

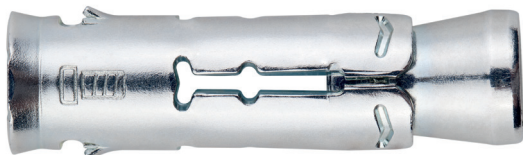

## Controlled torque expansion anchor, for use in hollow-core slabs

HC

ETA Assessed for multiple use for non-structural applications in hollow-core slabs. Zinc-plated sleeve. Zinc-plated cone.



### PRODUCT INFORMATION

#### DESCRIPTION

Metallic anchor, with female thread, expansion by controlled torque.

#### OFFICIAL DOCUMENTATION

- CE-1219-CPR-0117.
- ETA 15/0912 for multiple use for non-structural applications in hollow-core slabs.
- Declaration of performance DoP HC.

#### SIZES

M6 to M10.

#### DESIGN LOAD RANGE

From 1,9 to 7,8 kN.



#### BASE MATERIAL

Hollow-core slabs, concrete class  $\geq$  C40/50.



Hollow-core slabs

#### ASSESSMENTS

- Multiple use.



15  
Técnicas Expansivas S.L.  
Segador 13. Logroño, Spain  
ETA 15/0912  
1219  
Structural fixings in concrete



#### CHARACTERISTICS AND BENEFITS

- Easy installation.
- Use in hollow-core slabs.
- Use for medium loads.
- Pre-installation of the fixture.
- The collar doesn't allow the anchor to go through the hole, making the installation easier.
- For static and quasi-static loads.
- Three sizes assessed M6, M8 and M10.
- Suitable when reduced distance to edge and between anchors is required.
- Suitable for use with metric threaded rods and bolts.
- Available in INDEXcal.



#### MATERIALS

Sleeve: Carbon steel, zinc-plated  $\geq$  5  $\mu$ m.

Cone: Carbon steel, zinc-plated  $\geq$  5  $\mu$ m.



#### APPLICATIONS

- Fixings in suspenses ceilings, sprinkler and ventilation systems.
- Non-structural fixings, fittings in interiors and/or exteriors.
- Fixings of threaded rods.

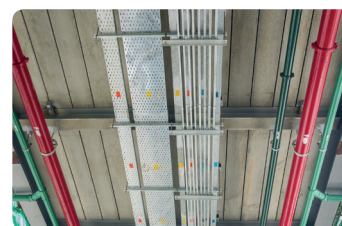
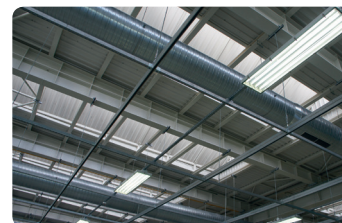



**MECHANICAL PROPERTIES**

Bolt diameter			M6	M8	M10			
$A_s$	(mm <sup>2</sup> )	Threaded area section	20,1	36,6	58,0			
Screw steel grade			4.6	4.8	5.6	5.8	6.8	8.8
$f_{uk}$	(N/mm <sup>2</sup> )	Screw characteristic resistance	400	400	500	500	600	800

**INSTALLATION DATA**

METRIC			M6	M8	M10
$d_0$	Nominal diameter of drill bit	[mm]	10	12	16
$T_{ins}$	Installation torque moment	[Nm]	10	20	30
$d_{t\leq}$	Diameter of clearance hole in the fixture	[mm]	7	9	12
$h_1$	Drill hole depth	[mm]	45	50	60
$h_{nom}$	Installation depth	[mm]	38	44	53
$l_s$	Bolt minimum length*	[mm]	$t_{fix} + 40$	$t_{fix} + 46$	$t_{fix} + 55$
$s_{cr,N}$	Critical spacing	[mm]	200	200	200
$c_{cr,N}$	Critical edge distance	[mm]	100	100	100
$s_{min}$	Minimum spacing	[mm]	100	100	100
$c_{min}$	Minimum edge distance	[mm]	60	70	90

\* $t_{fix}$  = thickness of fixture

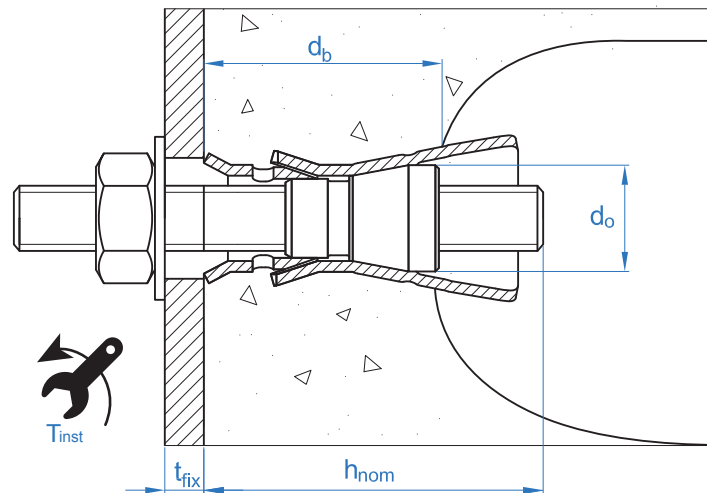



Code	INSTALLATION PRODUCTS
	Hammer drill
BHDSXXXXX	Concrete Drill bits
MOBOMBA	Blow pump
MORCEPKIT	Cleaning Brush
	Torque wrench
	Hexagonal socket

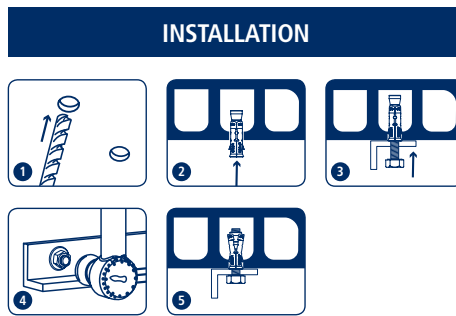

**HC**

### Resistance in hollow-core concrete $\geq$ C40/50 and for an isolated anchor, without effects of edge distance or spacing

Characteristic Resistance $F_{Rk}$						
ALL LOAD DIRECTIONS						
		Metric	M6	M8	M10	
$F_{Rk}$	Hollow-core concrete $\geq$ C40/50	[kN]	$d_b \geq 25; < 30$ mm	3,5	5,0	8,0
			$d_b \geq 30; < 40$ mm	7,0	10,0	14,0
			$d_b \geq 40$ mm	8,5	11,5	14,0

Design Resistance $F_{Rd}$						
ALL LOAD DIRECTIONS						
		Metric	M6	M8	M10	
$F_{Rd}$	Hollow-core concrete $\geq$ C40/50	[kN]	$d_b \geq 25; < 30$ mm	1,9	3,3	4,4
			$d_b \geq 30; < 40$ mm	3,9	6,7	7,8
			$d_b \geq 40$ mm	4,7	7,7	7,8

Maximum Loads Recommended $F_{rec}$						
ALL LOAD DIRECTIONS						
		Metric	M6	M8	M10	
$F_{rec}$	Hollow-core concrete $\geq$ C40/50	[kN]	$d_b \geq 25; < 30$ mm	1,4	2,4	3,2
			$d_b \geq 30; < 40$ mm	2,8	4,8	5,6
			$d_b \geq 40$ mm	3,4	5,5	5,6

### Simplified calculation method

#### European Technical Assessment ETA 15/0912

Simplified version of the calculation method according to ETAG 001, annex C. Resistance is calculated according to the data shown in assessment ETA 15/0912.

- Influence of concrete strength.
- Influence of edge distance.
- Influence of spacing between anchors.
- Valid for a group of two anchors.

The calculation method is based on the following simplification: **Different loads do not act on individual anchors, without eccentricity.**



#### INDEXcal

For a more precise calculation and to take more constructive provisions into account, INDEX Fixing Systems is developing a calculation software for multiple use for nonstructural applications in concrete.



**HC**

**ALL LOAD DIRECTIONS**

• Design resistance for all load directions:  $F_{Rd} = F_{Rd}^o \cdot \psi_s \cdot \psi_c$

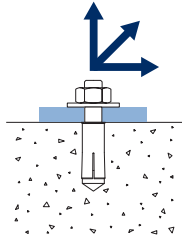

Design resistance $F_{Rd}$					
ALL LOAD DIRECTIONS					
		Metric	M6	M8	M10
$F_{Rd}$	Hollow-core concrete $\geq$ C40/50	[kN]			
		$d_b \geq 25; < 30$ mm	1,9	3,3	4,4
		$d_b \geq 30; < 40$ mm	3,9	6,7	7,8
		$d_b \geq 40$ mm	4,7	7,7	7,8



## Coefficients of influence

Influence of spacing (concrete cone) $\Psi_{s,N}$			
s [mm]	HC		
	M6	M8	M10
60	Invalid value		
70			
80			
90			
100	0,75	0,75	0,75
110	0,78	0,78	0,78
120	0,80	0,80	0,80
130	0,83	0,83	0,83
140	0,85	0,85	0,85
150	0,88	0,88	0,88
160	0,90	0,90	0,90
170	0,93	0,93	0,93
180	0,95	0,95	0,95
190	0,98	0,98	0,98
200	1,00	1,00	1,00
210	Value without reduction = 1		
220			
230			
240			
250			

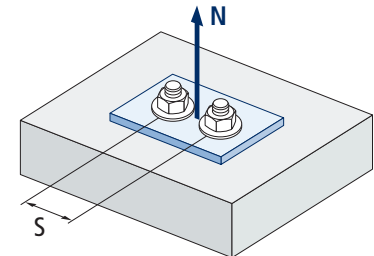

$$\Psi_{s,N} = 0,5 + \frac{s}{2 \cdot S_{cr,N}} \leq 1$$

Influence of concrete edge distance (concrete cone) $\Psi_{c,N}$			
c [mm]	HC		
	M6	M8	M10
60	0,70	Invalid value	
65	0,74		
70	0,77	0,77	
75	0,81	0,81	
80	0,85	0,85	0,85
85	0,88	0,88	0,88
90	0,92	0,92	0,92
95	0,96	0,96	0,96
100	1,00	1,00	1,00
105	Value without reduction = 1		
110			
115			
120			

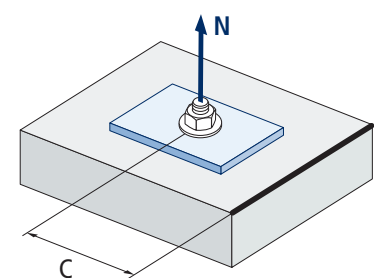

$$\Psi_{c,N} = 0,35 + \frac{0,5 \cdot c}{C_{cr,N}} + \frac{0,15 \cdot c^2}{C_{cr,N}^2} \leq 1$$



# HC

## FIRE RESISTANCE

Characteristic Resistance*			
	ALL LOAD DIRECTIONS		
	M6	M8	M10
RF30	0,20	0,37	0,87
RF60	0,18	0,33	0,75
RF90	0,14	0,26	0,58
RF120	0,10	0,18	0,46

\*The safety factor for design resistance under fire exposure is Resistance  $\gamma_{M,fi}=1$  (in absence of other national regulations). As a result the Characteristic Resistance is the same as Design.

Maximum Load Recommended			
	ALL LOAD DIRECTIONS		
	M6	M8	M10
RF30	0,14	0,30	0,60
RF60	0,13	0,20	0,50
RF90	0,10	0,20	0,40
RF120	0,07	0,10	0,30

## RANGE

Code	Size	Ø drill bit		
HCM06	M6	10	100	600
HCM08	M8	12	50	600
HCM10	M10	16	25	300