

INDEX[®]
A PERFECT FIXING

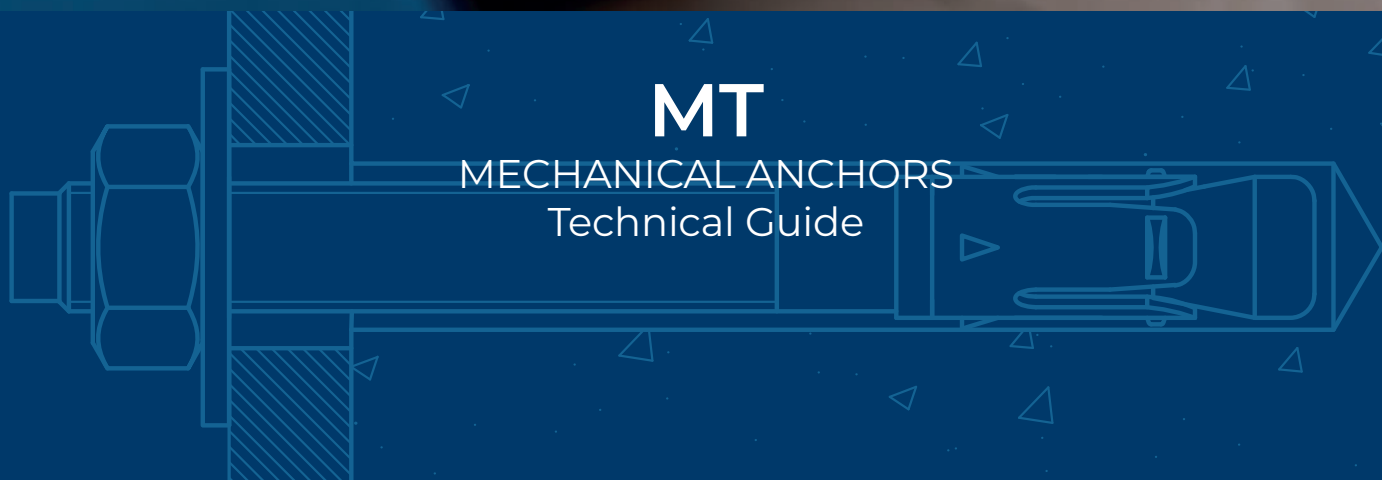

MT

MECHANICAL ANCHORS
Technical Guide







INTRODUCTION

INDEX Fixing Systems offers you new technical material which will allow you to broaden your knowledge of the world of fixing systems.

Fixing elements using **metal anchors** offers a vast number of possibilities, depending on the required result. Selection criteria, such as high quality, assessment certifications or coatings, lead us to choose one anchor over another in order to meet required expectations and demands.

With this guide we hope to show the **basic working principles of our MT Through-bolt anchor range**, furthering your knowledge to choose the best fixing solution for each scenario. It has been elaborated to help planners, architects, civil engineers and building engineers in their daily work. Whether for design work or project calculation for correct installation, with the help of this information, daily development problems **may be solved quickly and concisely**.

In addition, INDEX Fixing Systems wishes to emphasize the importance and responsibility which comes implicitly both with the calculation and installation of an anchor in a structure, bridge or other application. All study processes must be carried out **rigorously with expert technical knowledge**. We understand that it is the responsibility of all professionals to ensure that the most suitable anchor is properly chosen for each particular situation.

All products must be installed in accordance with the information given in this guide so as to comply with characteristics indicated within.

We would like to thank our customers, users, and staff for their help and collaboration with this new guide. We hope it is of great help and assistance in your professional work.

Technical Department
INDEX Fixing Systems





CONTENTS

06	Company commitment
08	We manufacture
10	Technical commitment
12	MT anchor components / Elements in a fixing
13	MT anchor characteristics
14	Regulations (Assessments)
15	Assessment options
16	Selection Table
18	Types of mechanical anchor failure
19	MTP
33	MTP-X
47	MTP-G
61	MTP-A4
75	MTH
89	MTH-A2
103	MTH-A4
117	MTA



At **INDEX**® we are manufacturers and industrial suppliers of fixing systems, offering global solutions adapted to your business needs.

BUT WE ARE MUCH MORE THAN THAT. WE ARE A LARGE TEAM ENGAGED IN CONTINUOUS RESEARCH, DEVELOPMENT AND INNOVATION, AND, LET'S FACE IT, WE'RE MORE THAN A LITTLE OBSESSED WITH ACHIEVING OUR GOAL: TO PROVIDE THE PERFECT FIXING.

Whatever the size of your business, at **INDEX**® we will find the perfect fixing for your needs.



These are just some of the reasons why **INDEX® STANDS OUT**



AVAILABILITY AND WIDE PRODUCT RANGE

Over 10,000 products permanently in stock (guaranteed).



WE WORK WITH THE CHANNEL

We sell through the distribution channel, enabling us to gain first-hand market knowledge.



WE ARE EXPERT MANUFACTURERS

Over 30 years of experience in manufacturing fixing systems enables us to ensure the maximum quality of all our products, the best service, and competitive overall costs.



CERTIFIED QUALITY

We hold the most important certificates and approvals, verifying that all of our products meet the highest quality standards.



INTERNATIONAL PRESENCE

We are a global company with sales in more than 90 countries on the five continents and facilities in Spain, China and Mexico.



ENGINEERING AND TECHNICAL SUPPORT SERVICES

We support our customers with structural design and calculations, joint site visits, and technical training on topics related to fixing systems.



QUALITY CUSTOMER SERVICE

Our customers are at the heart of everything we do. We have a team of over 300 people at your service.



INDEX SPACE ESTUDIO

We have the perfect display solution for all our customers, whatever their business.





AVAILABILITY AND WIDE PRODUCT RANGE

We are specialists in anchors, screws, clamps, and installation systems. We have the widest range of products, with over 10,000 items permanently in stock (guaranteed) at our facilities in Spain, China, and Mexico (over 45,000 m²).



WE HAVE ALL THE FIXINGS YOU COULD POSSIBLY NEED AND WE ARE CONSTANTLY INCORPORATING NEW PRODUCTS: anchors, screws, clamps, installation systems, etc.





WE ARE EXPERT MANUFACTURERS

Our control over the entire production process combined with over 30 years of experience in manufacturing fixing systems enables us to ensure the maximum quality of all our products, the best service, and competitive overall costs.



**OVER 30 YEARS
OF EXPERIENCE**

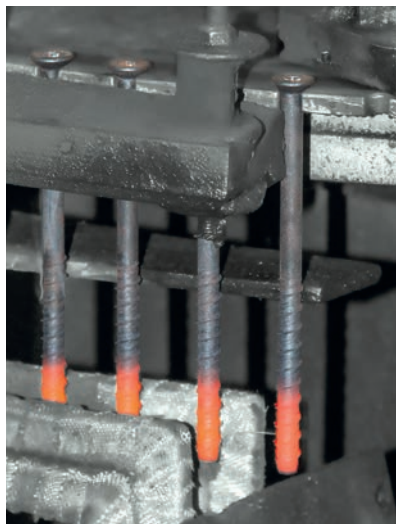



ENGINEERING AND TECHNICAL SUPPORT SERVICES

We offer full technical consultancy through our team of specialist engineers. We have a technical assistance service, our own specialised software, and the most extensive range of technical documentation.

And most importantly, our team will support you in structural design and calculations, site visits, and technical training on everything related to fixing systems.

TECHNICAL ASSISTANCE AND CONSULTING SERVICE



TECHNICAL TRAINING

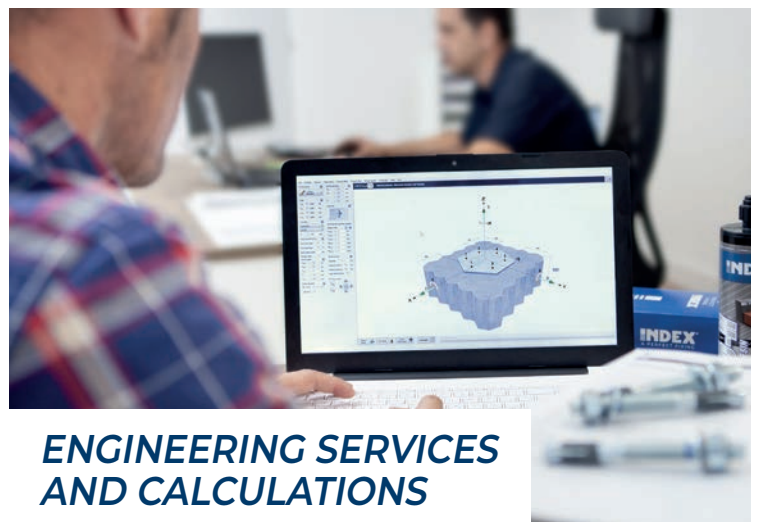

ENGINEERING SERVICES AND CALCULATIONS

SPECIALISED SOFTWARE



INDEXcal



INDEXwood

We have the best software to meet the needs of each specific case.

INDEXcal software to calculate anchors and to design structural solutions.

INDEXwood software to design and calculate timber structures.

INDEXmor online tool to calculate the required number of chemical cartridges according to different parameters.



INDEXmor



WIDE RANGE OF TECHNICAL DOCUMENTATION AVAILABLE

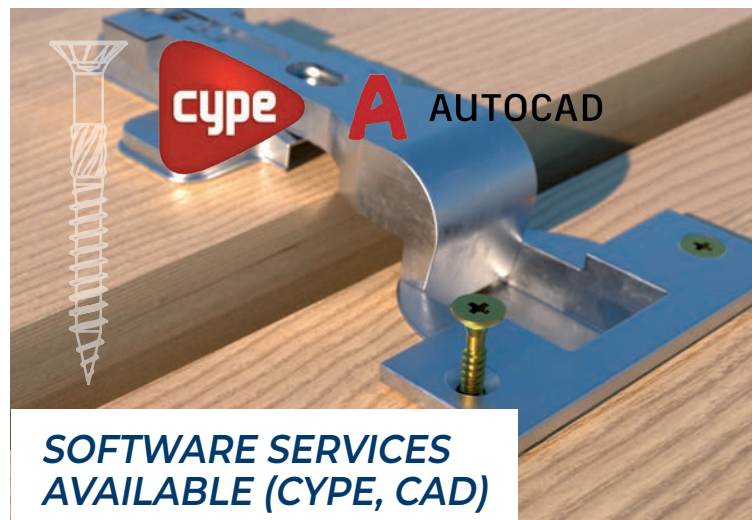

SOFTWARE SERVICES AVAILABLE (CYPE, CAD)

MT anchor components

Letter indicating anchor length



Lowering to protect thread during installation

Assembled nut and washer

Installation depth indicator

Full thread

Identification mark: size and length

3-segment clip with elaborated geometry, to prevent anchor spinning and to ensure correct expansion

Special lubricant to reduce friction between cone and clip - improving anchor expansion

Elements in a fixing

LOAD:
Strain supported by the fixing system

ELEMENT TO BE FIXED:
Element on which external loads are applied

BASE MATERIAL:
Element to which loads are transmitted

ANCHOR:
Element which serves as a union between the element to be fixed and the base material

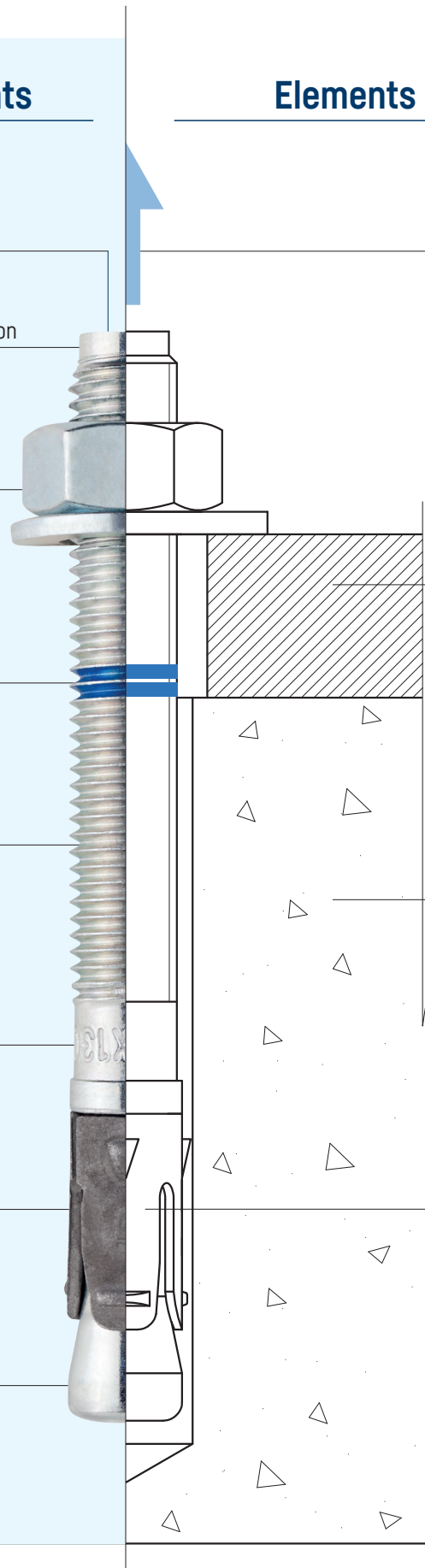



Characteristics of an MT-Anchor

The MT-Anchor is characterized by having an **expansive clip**. While applying torque to the anchor, the clip expands due to the cone-shaped bolt, resulting into pression on the inner side of the hole, which originates the necessary friction between the clip and the base material. Thus the installation is fulfilled.

Main advantages of this anchor:

- **Fast to use**, as it can support the load immediately after it has been installed.
- High **resistance** values.
- **Cheap and easy installation**.
- Available at **many diameters and lengths**.

The following steps must be followed for a correct installation of this anchor:

Critical aspects of this anchor to be considered:

- Ensure a correct expansion of the anchor by applying the torque value recommended by the manufacturer.
- Use a calibrated torque wrench with an appropriate torque range.
- Ensure the correct installation and cleanliness conditions recommended.

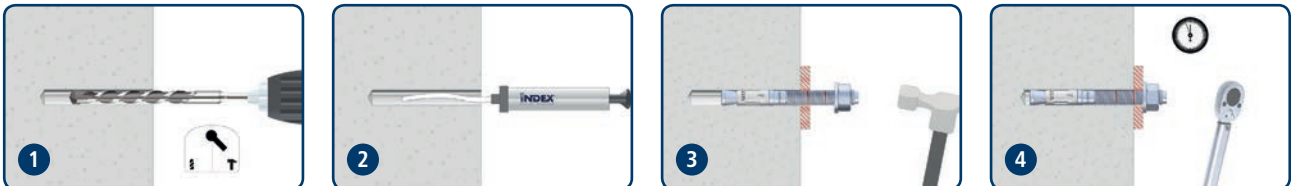

Installation procedure of an MT anchor:

- 1 DRILLING:** Check the concrete base is compact and porosity is insignificant. Suitable for wet, dry or flooded drill holes. Use drill in hammer mode. Drill to the specified diameter and depth values.
- 2 BLOW AND CLEAN:** Clear the drill holes completely of dust and fragments. Use air pump and brush.
- 3 INSTALL:** Insert the anchor in the hole until the red ring mark is flat with concrete surface. Use hammer in case of need; DOMTA tool could be used alternatively. The installation could be done through the fixture baseplate.
- 4 APPLY TORQUE:** Apply nominal installation torque using a torque wrench. Once installed it can be verified the total length of the anchor through the letter on bolt tip.



REGULATIONS (Assessments)

CE MARKING



The **CE marking** is the way through which the manufacturer declares that the product complies with the basic requirements of the works.

Regulations affecting construction products are set out in “**Construction Products Regulation 305/2011**” [CPR], where basic requirements established therein must be met with regard to:

- Mechanical resistance and stability.
- Safety in case of fire.
- Health, hygiene and the environment.
- Safety and accessibility of use.
- Protection against noise.
- Energy saving and thermal insulation.
- Sustainable use of natural resources.

EOTA



The CPR establishes the European Evaluation Document DET 330232-00-0601 (mechanical anchors for use in concrete), where the necessary testing and applicable evaluation criteria are indicated in order to obtain, voluntarily, a **European Technical Assessment (ETA)**. Based on this, and **under their responsibility, the manufacturer must issue a Performance Declaration and apply the CE marking on the construction products**. The European assessment is performed by a Technical Evaluation Organism belonging to EOTA (European Organization for Technical Assessments).

The Eurocode 2 [EN 1992-4] - Design of concrete structures - Part 4: Design of fastenings for use in concrete provides the anchor calculation method based on 12 assessment types depending on the type of concrete, concrete resistance, and the calculation method.

ETA



The most common evaluation options on the market are:

- **Option 1** or use of anchors in cracked and non-cracked concrete.



- **Option 7** for use of anchors in non-cracked concrete.





ASSESSMENT OPTIONS

Option	Cracked	Non-cracked	Unique resistance for any concrete type	Individualized resistance for any concrete type	Unique resistance for any direction	Individualized resistance for tension and shear loads	Reduced values for spacing and edge distances	Calculation method according to prEN 1992-4 [16]				
1	✓	✓	X	✓	X	✓	✓	A				
2			✓	X								
3			X	✓	✓	X		X	C			
4			✓	X								
5			X	✓								
6			✓	X	X	✓	X	X	A			
7	X	✓										
8	✓	X	✓	X						X	X	B
9	X	✓										
10	✓	X										
11	X	✓	✓	X						X	X	C
12	✓	X										



Some anchors are assessed for **seismic loads**. For seismic applications, fixings are calculated according to the method established in TR045. This calculation guide establishes different zones and building classes, according to seismic activity. Depending on this classification, it receives **category C1 or C2**. As a synthesis of the concept, it may be determined that category C1 is used for non-structural applications whereas category C2 is used in structural applications.



For applications under **fire exposure**, fixings are calculated according to the method established in TR020 "Evaluation of anchorages in concrete concerning resistance to fire".

This evaluation is for anchors in standard concrete with strength of at least C20/25 and at most C50/60 used for normal structures under fire exposure.

The determination of fire resistance duration is established according to the conditions provided in EN 1363-1:1999-10 using the "Standard temperature / time Curve".

In general, anchor fire resistance duration depends mainly on the configuration of the structure itself (base materials, anchors including material to be fixed).



SELECTION TABLE

		ASSESSMENTS					
		CE	ETA OPTION 1	ETA OPTION 7	Fire	C1	C2 & C1
MTP		•	•		•	•	•
MTP-G		•	•		•		
MTP-X		•	•		•	•	•
MTP-A4		•	•		•	•	•
MTH		•		•	•		
MTH-A2		•		•	•		
MTH-A4		•		•	•		
MTA							

CE MARKING

ASSESSED OPTION 1
OPTION 1

ASSESSED OPTION 7
OPTION 7

SEISMIC ASSESSMENT C1

SEISMIC ASSESSMENT C1 & C2

FIRE RESISTANCE



SELECTION TABLE

BASE MATERIAL				COATING				CORROSION RESISTANCE			INSTALLATION DEPTH	
•	•	•	•					•			•	
•	•	•	•						•		•	
•	•	•	•					•			•	
•	•	•	•							•	•	
•		•	•					•			•	•
•		•	•							•	•	•
•		•	•							•	•	•
•		•	•					•			•	•



NON-CRACKED CONCRETE



CRACKED CONCRETE



REINFORCED CONCRETE



STONE



ZINC-PLATED



ATLANTIS C3-L



A2 STAINLESS



A4 STAINLESS



INDOOR USE



MEDIUM PERFORMANCE



HIGH PERFORMANCE

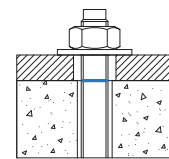

STANDARD
INSTALLATION
DEPTH

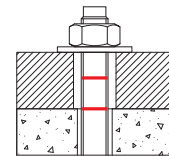

REDUCED
INSTALLATION
DEPTH



TYPES OF MECHANICAL ANCHOR FAILURE

This document presents different technical aspects of specified anchors. It specifies different situations in which a correctly installed anchor may fail. Explained below are the **main failures** may suffer **and why they occur**.

It differs depending on the loads to which the anchors are subjected. The failures have been divided into those to which a tension load is applied, and those to which a shear load is applied

TENSION

Steel failure

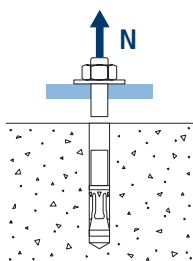

This occurs when an anchor is subjected to a tension load higher than the steel strength. The failure occurs in the clip area – part of the anchor will remain inside the installation hole, splitting above the clip.

Pull-out failure

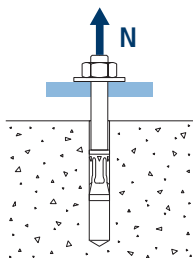

This occurs when the load applied to the anchor exceeds the frictional force between the clip and the internal face of the concrete, resulting in a complete anchor pull-out.

Concrete conr or splitting failure

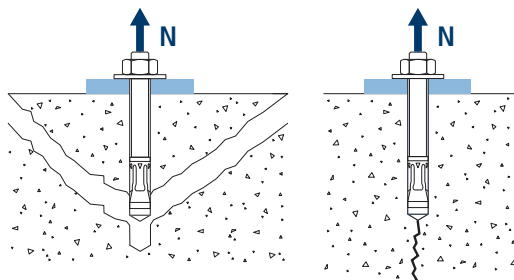

This occurs when the load to which the anchor is subjected is greater than the strength of the concrete; as a result the base material cracks in the shape of an inverted cone. In some cases, the result of the crack is a complete splitting of the base material which nullifies the anchor's fixing capacity.

SHEAR

Steel failure without lever arm

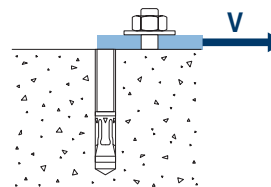

This occurs when an anchor is subjected to a shear load greater than the steel strength. The failure takes place on the surface level of the base material

Concrete edge failure

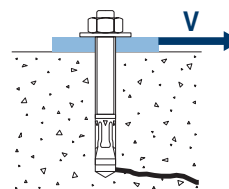

This occurs when the load applied to the anchor produces a crack in the concrete between its edge and the anchor.

Pry-out failure

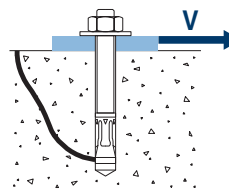

This occurs when the load to which the anchor is subjected causes pry-out in the neutral zone of the base material from where the shear force is applied.



Through-bolt expansion anchor with controlled torque, for use in cracked and non cracked concrete

MTP

ETA Assessed Option 1. Zinc-plated shaft. A4 Stainless clip.

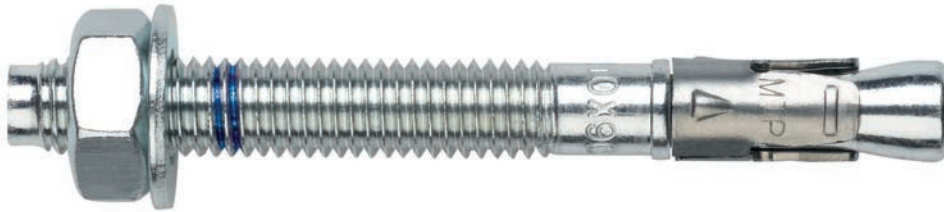

PRODUCT INFORMATION

DESCRIPTION

Metallic anchor, with male thread, expansion by controlled torque.

OFFICIAL DOCUMENTATION

- AVCP-1219-CPR-0053.
- ETA 12/0397 option 1.
- Declaration of Performance DoP MTP.

SIZES

M8x50 to M24x235.

DESIGN LOAD RANGE

From 5,00 to 33,3 kN [non cracked].
From 2,7 to 20,0 kN [cracked].



BASE MATERIAL

Concrete class from C20/25 to C50/60
cracked or non-cracked.



Stone



Concrete



Reinforced Concrete



Cracked Concrete

ASSESSMENTS

- Option 1 [Cracked and non-cracked concrete]
- Fire Resistance R30-120
- Seismic C1 M10 ÷ M16
- Seismic C2 M12 ÷ M16



12
Técnicas Expansivas S.L.
Segador 13. Logroño. Spain
ETA 12/0397
1219
Structural fixings in concrete



CHARACTERISTICS AND BENEFITS

- Easy installation.
- Use in cracked and non-cracked concrete.
- Use for medium-heavy duty loads.
- Pre-installation or through the drill-hole of the fixture.
- Variety of lengths and diameters: flexibility in assembly.
- For static and quasi-static loads.
- Available at INDEXcal.



MATERIALS

Shaft: Cold-formed steel, zinc-plated $\geq 5 \mu\text{m}$.

Washer: DIN 125 or DIN 9021, zinc-plated $\geq 5 \mu\text{m}$.

Nut: DIN 934, zinc-plated $\geq 5 \mu\text{m}$.

Clip: A4 Stainless steel



APPLICATIONS

- Anchor plates.
- Metallic structures.
- Bridges.
- Urban fitments.
- Protective fences.
- Catenaries.
- Elevators.
- Pipe supports.

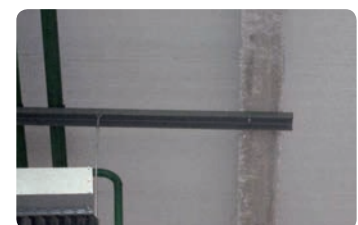



MECHANICAL PROPERTIES

			M8	M10	M12	M16	M20	M24
Cone area section								
A_s	(mm ²)	Cone area section	22,9	41,8	55,4	103,9	176,7	298,6
$f_{u,s}$	(N/mm ²)	Characteristic tension resistance	790	750	730	700	660	600
$f_{y,s}$	(N/mm ²)	Yield strength	632	600	585	560	530	480
Threaded area section								
A_s	(mm ²)	Cone area section	36,6	58,0	84,3	157,0	245,0	353,0
$f_{u,s}$	(N/mm ²)	Characteristic tension resistance	600	600	600	600	600	600
$f_{y,s}$	(N/mm ²)	Yield Strength	480	480	480	480	480	480

INSTALLATION DATA

SIZE			M8	M10	M12	M16	M20	M24
Code			AP08XXX	AP10XXX	AP12XXX	AP16XXX	AP20XXX	AP24XXX
d_0	Nominal diameter of drill bit	[mm]	8	10	12	16	20	24
T_{ins}	Installation torque moment	[Nm]	20	40	60	100	200	250
$d_{f\leq}$	Diameter of clearance hole in the fixture	[mm]	9	12	14	18	22	26
h_1	Minimum drill hole depth	[mm]	60	75	85	105	125	155
h_{nom}	Installation depth	[mm]	55	68	80	97	114	143
h_{ef}	Effective embedment depth	[mm]	48	60	70	85	100	125
h_{min}	Minimum base material thickness	[mm]	100	120	140	170	200	250
t_{fix}	Maximum thickness of fixture	[mm]	L - 66	L - 80	L - 96	L - 117	L-138	L-170
$s_{cr,N}$	Critical spacing	[mm]	144	180	210	255	300	375
$c_{cr,N}$	Critical edge distance	[mm]	72	90	105	128	150	188
$s_{cr,sp}$	Critical distance (splitting)	[mm]	288	300	350	425	500	560
$c_{cr,sp}$	Critical edge distance (splitting)	[mm]	144	150	175	213	250	280
s_{min}	Minimum spacing	[mm]	50	60	70	85	100	125
c_{min}	Minimum edge distance	[mm]	50	60	70	85	100	125
SW	Installation wrench		13	17	19	24	30	30

*L = Total anchor length

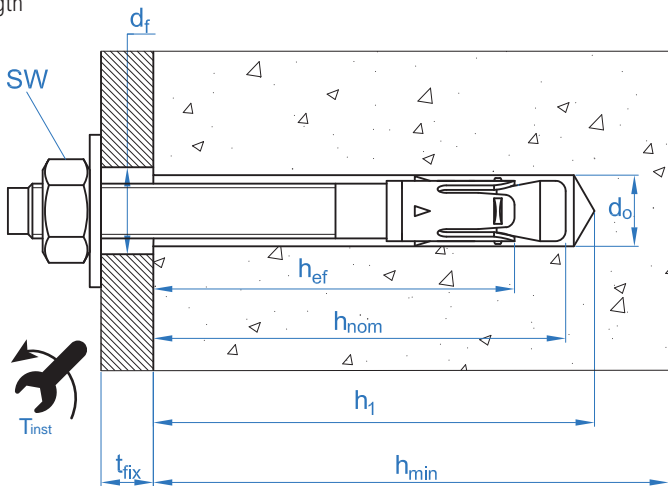



Code	INSTALLATION PRODUCTS
	Hammer drill
BHDSXXXXX	Concrete Drill bits
MOBOMBA	Blow pump
MORCEPKIT	Cleaning Brush
DOMTAXX	Installation hammering tool
	Torque wrench
	Hexagonal socket

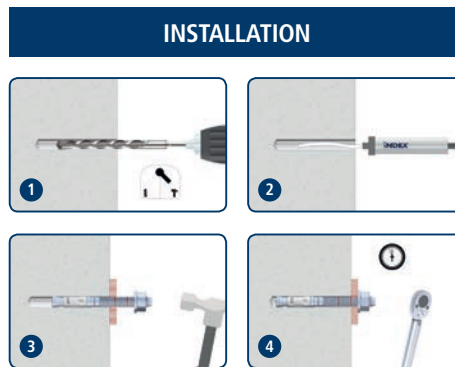

Resistances in C20/25 concrete for an isolated anchor, without effects of edge distance or spacing

Characteristic Resistance N_{Rk} and V_{Rk}															
TENSION							SHEAR								
Size		M8	M10	M12	M16	M20	M24	Size		M8	M10	M12	M16	M20	M24
N_{Rk}	Non-cracked concrete [kN]	9,0	16,0	20,0	35,0	50,0	50,0	V_{Rk}	Non-cracked concrete [kN]	11,0	17,4	25,3	47,1	73,1	84,7
N_{Rk}	Cracked concrete [kN]	5,0	9,0	12,0	25,0	30,0	30,0	V_{Rk}	Cracked concrete [kN]	11,0	17,4	25,3	47,1	73,1	84,7

Design Resistance N_{Rd} and V_{Rd}															
TENSION							SHEAR								
Size		M8	M10	M12	M16	M20	M24	Size		M8	M10	M12	M16	M20	M24
N_{Rd}	Non-cracked concrete [kN]	5,0	10,6	13,3	23,3	33,3	27,7	V_{Rd}	Non-cracked concrete [kN]	8,8	13,9	20,2	37,6	58,4	67,7
N_{Rd}	Cracked concrete [kN]	2,7	6,0	8,0	16,6	20,0	16,6	V_{Rd}	Cracked concrete [kN]	8,8	13,9	20,2	37,6	58,4	67,7

Maximum Loads Recommended N_{rec} and V_{rec}															
TENSION							SHEAR								
Size		M8	M10	M12	M16	M20	M24	Size		M8	M10	M12	M16	M20	M24
N_{rec}	Non-cracked concrete [kN]	3,5	7,6	9,5	16,6	23,8	19,8	V_{rec}	Non-cracked concrete [kN]	6,3	9,9	14,4	26,9	41,7	48,4
N_{rec}	Cracked concrete [kN]	2,0	4,2	5,7	11,9	14,2	11,9	V_{rec}	Cracked concrete [kN]	6,3	9,9	14,4	26,9	41,7	48,4

Simplified calculation method

European Technical Assessment ETA 12/0397

Simplified version of the calculation method according to ETAG 001, annex C. Resistance is calculated according to the data shown in assessment ETA 12/0397.

- Influence of concrete strength.
- Influence of edge distance.
- Influence of spacing between anchors.
- Influence of reinforcements.
- Influence of base material thickness.
- Influence of load application angle.
- Valid for a group of two anchors.



INDEXcal

For a more accurate calculation and to take more constructive provisions into account, we recommend using our calculation program INDEXcal. It may be easily downloaded from our website www.indexfix.com



MTP

TENSION LOADS

- Steel design resistance: $N_{Rd,s}$
- Pull-out design resistance: $N_{Rd,p} = N_{Rd,p}^o \cdot \Psi_c$
- Concrete cone design resistance: $N_{Rd,c} = N_{Rd,c}^o \cdot \Psi_b \cdot \Psi_{s,N} \cdot \Psi_{c,N} \cdot \Psi_{re,N}$
- Concrete splitting design resistance: $N_{Rd,sp} = N_{Rd,c}^o \cdot \Psi_b \cdot \Psi_{s,sp} \cdot \Psi_{c,sp} \cdot \Psi_{re,N} \cdot \Psi_{h,sp}$

Steel Design resistance							
$N_{Rd,s}$							
Size		M8	M10	M12	M16	M20	M24
N_{Rd}^o	[kN]	12,1	20,9	26,9	48,5	77,7	119,5

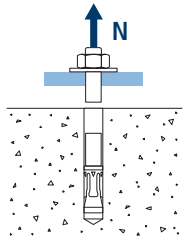

Pull-out design resistance							
$N_{Rd,p} = N_{Rd,p}^o \cdot \Psi_c$							
Size		M8	M10	M12	M16	M20	M24
$N_{Rd,p}^o$	Non-cracked concrete [kN]	5,0	10,6	13,3	23,3	33,3	27,7
$N_{Rd,p}^o$	Cracked concrete [kN]	2,7	6,0	8,0	16,6	20,0	16,6

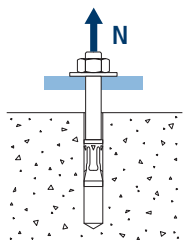

Concrete cone design resistance							
$N_{Rd,c} = N_{Rd,c}^o \cdot \Psi_b \cdot \Psi_{s,N} \cdot \Psi_{c,N} \cdot \Psi_{re,N}$							
Concrete splitting design resistance*							
$N_{Rd,sp} = N_{Rd,c}^o \cdot \Psi_b \cdot \Psi_{s,sp} \cdot \Psi_{c,sp} \cdot \Psi_{re,N} \cdot \Psi_{h,sp}$							
Size		M8	M10	M12	M16	M20	M24
$N_{Rd,c}^o$	Non-cracked concrete [kN]	9,3	15,6	19,6	26,3	33,6	39,1
$N_{Rd,c}^o$	Cracked concrete [kN]	6,6	11,1	14,0	18,8	24,0	27,9

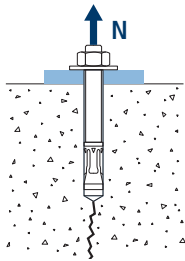
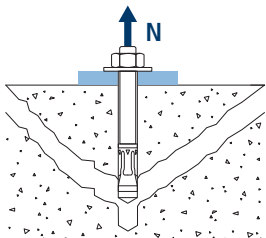

*Concrete splitting design resistance must only be considered for non-cracked concrete.



MTP

Coefficients of influence

Influence of concrete strength resistance in pul-out failure Ψ_c

		M8	M10	M12	M16	M20	M24
Ψ_c	C 20/25	1,00	1,00	1,00	1,00	1,00	1,00
	C 30/37	1,22	1,16	1,22	1,22	1,16	1,22
	C 40/50	1,41	1,31	1,41	1,41	1,31	1,41
	C 50/60	1,55	1,41	1,55	1,55	1,41	1,55

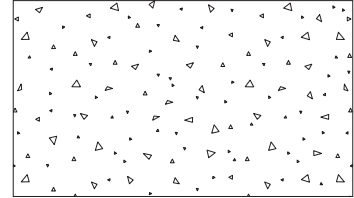
Influence of concrete strength in concret cone and splitting failure Ψ_b

		M8	M10	M12	M16	M20	M24
Ψ_b	C 20/25	1,00					
	C 30/37	1,22					
	C 40/50	1,41					
	C 50/60	1,55					

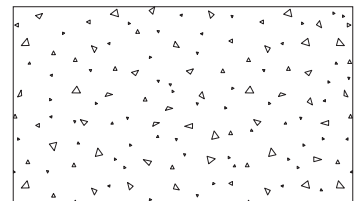

$$\Psi_b = \sqrt{\frac{f_{ck,cube}}{25}} \geq 1$$



MTP

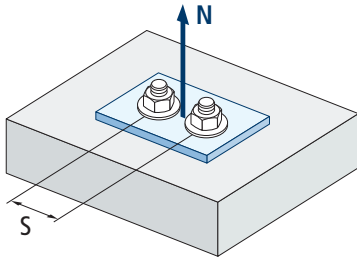

$$\psi_{s,N} = 0,5 + \frac{s}{2 \cdot s_{cr,N}} \leq 1$$

Influence of spacing (concrete cone) $\psi_{s,N}$						
s [mm]	MTP					
	M8	M10	M12	M16	M20	M24
50	0,67					
55	0,69					
60	0,71	0,67				
65	0,73	0,68				
70	0,74	0,69	0,67			
80	0,78	0,50	0,50			
85	0,80	0,74	0,70	0,67		
90	0,81	0,75	0,71	0,68		
100	0,85	0,78	0,74	0,70	0,67	
105	0,86	0,79	0,75	0,71	0,68	
110	0,88	0,81	0,76	0,72	0,68	
120	0,92	0,83	0,79	0,74	0,70	
125	0,93	0,85	0,80	0,75	0,71	0,67
126	0,94	0,85	0,80	0,75	0,71	0,67
128	0,94	0,86	0,80	0,75	0,71	0,67
130	0,95	0,86	0,81	0,75	0,72	0,67
135	0,97	0,88	0,82	0,76	0,73	0,68
144	1,00	0,90	0,84	0,78	0,74	0,69
150		0,92	0,86	0,79	0,75	0,70
165		0,96	0,89	0,82	0,78	0,72
170		0,97	0,90	0,83	0,78	0,73
180		1,00	0,93	0,85	0,80	0,74
195			0,96	0,88	0,83	0,76
200			0,98	0,89	0,83	0,77
210			1,00	0,91	0,85	0,78
220				0,93	0,87	0,79
225				0,94	0,88	0,80
252				0,99	0,92	0,84
255				1,00	0,93	0,84
260					0,93	0,85
300					1,00	0,90
309						0,91
310						0,91
375						1,00

Value without reduction = 1



Influence of spacing (concrete splitting) $\psi_{s,sp}$						
s [mm]	MTP					
	M8	M10	M12	M16	M20	M24
50	0,59					
55	0,60					
60	0,60	0,60				
65	0,61	0,61				
70	0,62	0,62	0,60			
80	0,64	0,63	0,61			
85	0,65	0,64	0,62	0,60		
90	0,66	0,65	0,63	0,61		
100	0,67	0,67	0,64	0,62	0,60	
110	0,69	0,68	0,66	0,63	0,61	
125	0,72	0,71	0,68	0,65	0,63	0,61
128	0,72	0,71	0,68	0,65	0,63	0,61
135	0,73	0,73	0,69	0,66	0,64	0,62
140	0,74	0,73	0,70	0,66	0,64	0,63
150	0,76	0,75	0,71	0,68	0,65	0,63
160	0,78	0,77	0,73	0,69	0,66	0,64
165	0,79	0,78	0,74	0,69	0,67	0,65
168	0,79	0,78	0,74	0,70	0,67	0,65
180	0,81	0,80	0,76	0,71	0,68	0,66
192	0,83	0,82	0,77	0,73	0,69	0,67
200	0,85	0,83	0,79	0,74	0,70	0,68
210	0,86	0,85	0,80	0,75	0,71	0,69
220	0,88	0,87	0,81	0,76	0,72	0,70
260	0,95	0,93	0,87	0,81	0,76	0,73
288	1,00	0,98	0,91	0,84	0,79	0,76
300		1,00	0,93	0,85	0,80	0,77
336			0,98	0,90	0,84	0,80
350			1,00	0,91	0,85	0,81
412				0,98	0,91	0,87
425				1,00	0,93	0,88
500	Value without reduction = 1				1,00	0,95
510						0,96
560						1,00

MTP

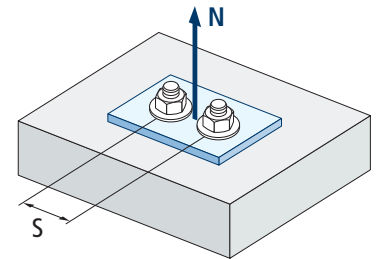

$$\psi_{s,sp} = 0,5 + \frac{s}{2 \cdot s_{cr,sp}} \leq 1$$



MTP

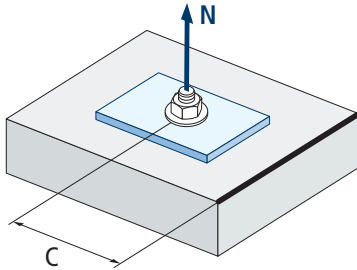

$$\psi_{c,sp} = 0,35 + \frac{0,5 \cdot c}{C_{cr,sp}} + \frac{0,15 \cdot c^2}{C_{cr,sp}^2} \leq 1$$

Influence of concrete edge distance (splitting) $\psi_{c,sp}$						
c [mm]	MTP					
	M8	M10	M12	M16	M20	M24
50	0,54					
60	0,58	0,57				
65	0,61	0,59				
70	0,63	0,62	0,57			
75	0,65	0,64	0,59			
80	0,67	0,66	0,61			
83	0,69	0,67	0,62			
84	0,69	0,68	0,62			
85	0,70	0,68	0,63	0,57		
90	0,72	0,70	0,65	0,59		
96	0,75	0,73	0,67	0,61		
100	0,77	0,75	0,68	0,62	0,57	
105	0,79	0,77	0,70	0,63	0,59	
110	0,82	0,80	0,72	0,65	0,60	
125	0,90	0,87	0,78	0,70	0,64	0,60
128	0,91	0,89	0,80	0,70	0,65	0,61
130	0,92	0,90	0,80	0,71	0,65	0,61
135	0,95	0,92	0,82	0,73	0,66	0,63
144	1,00	0,97	0,86	0,76	0,69	0,65
150		1,00	0,89	0,78	0,70	0,66
168			0,97	0,84	0,75	0,70
175			1,00	0,86	0,77	0,72
180				0,88	0,79	0,73
206				0,97	0,86	0,80
213				1,00	0,88	0,82
250					1,00	0,92
255						0,93
280						1,00

Invalid value

Value without reduction = 1



Influence of concrete edge distance (concrete cone) $\Psi_{c,N}$						
c [mm]	MTP					
	M8	M10	M12	M16	M20	M24
50	0,77					
53	0,80					
60	0,87	0,75				
63	0,90	0,77				
65	0,92	0,79				
70	0,98	0,83	0,75			
72	1,00	0,85	0,76			
75		0,87	0,78			
80		0,91	0,82			
83		0,94	0,84			
85		0,96	0,85	0,75		
90		1,00	0,89	0,78		
98			0,95	0,82		
100			0,96	0,83	0,75	
105			1,00	0,86	0,77	
110				0,89	0,80	
113				0,91	0,81	
125				0,98	0,87	0,75
126				0,99	0,88	0,75
128				1,00	0,89	0,76
135					0,92	0,79
150					1,00	0,84
155						0,86
188						1,00

Invalid value

Value without reduction = 1

MTP

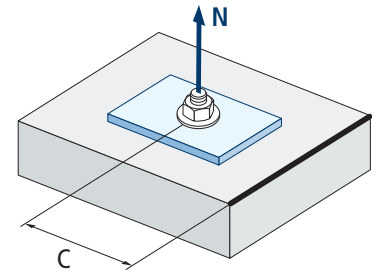

$$\Psi_{c,N} = 0,35 + \frac{0,5 \cdot c}{C_{cr,N}} + \frac{0,15 \cdot c^2}{C_{cr,N}^2} \leq 1$$

Influence of reinforcements $\Psi_{re,N}$						
$\Psi_{re,N}$	MTP					
	M8	M10	M12	M16	M20	M24
	0,74	0,80	0,85	0,93	1,00	1,00

*This factor only applies for a high density of reinforcements. If in the area of the anchor there are reinforcements with a distancing of ≥ 150 mm (any diameter) or with a diameter ≤ 10 mm and a distancing of ≥ 100 mm, a $f_{re,N} = 1$ factor may be applied.

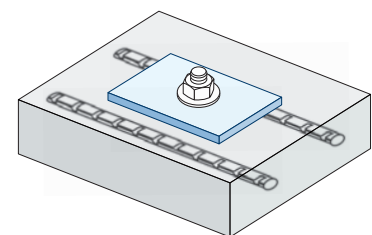

$$\Psi_{re,N} = 0,5 + \frac{h_{ef}}{200} \leq 1$$

Influence of base material thickness $\Psi_{h,sp}$											
$\Psi_{h,sp}$	MTP										
	h/h _{ef}	2,00	2,20	2,40	2,60	2,80	3,00	3,20	3,40	3,60	$\geq 3,68$
	$\Psi_{h,sp}$	1,00	1,07	1,13	1,19	1,25	1,31	1,37	1,42	1,48	1,50

$$\Psi_{h,sp} = \left(\frac{h}{2 \cdot h_{ef}} \right)^{2/3} \leq 1,5$$

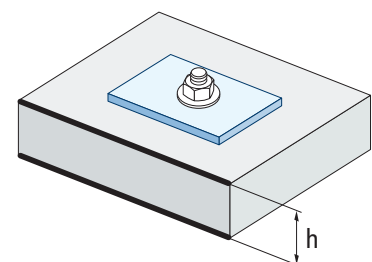



MTP

SHEAR LOADS

- Steel design resistance without lever arm: $V_{Rd,s}$
- Pry-out design resistance: $V_{Rd,cp} = k \cdot N_{Rd,c}^o$
- Concrete edge design resistance: $V_{Rd,c} = V_{Rd,c}^o \cdot \psi_b \cdot \psi_{se,V} \cdot \psi_{c,V} \cdot \psi_{re,V} \cdot \psi_{\alpha,V} \cdot \psi_{h,V}$

		Steel design resistance					
		$V_{Rd,s}$					
Size		M8	M10	M12	M16	M20	M24
$V_{Rd,s}$	[kN]	8,8	13,9	20,2	37,6	58,8	67,7

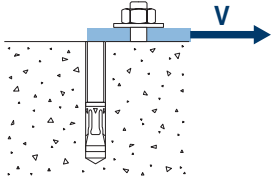

		Pry-out design resistance*					
		$V_{Rd,cp} = k \cdot N_{Rd,c}^o$					
Size		M8	M10	M12	M16	M20	M24
k		1	2	2	2	2	2

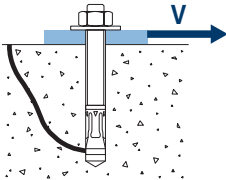

* $N_{Rd,c}^o$ Concrete cone design resistance for tension loads

		Concrete edge resistance						
		$V_{Rd,c} = V_{Rd,c}^o \cdot \psi_b \cdot \psi_{se,V} \cdot \psi_{c,V} \cdot \psi_{re,V} \cdot \psi_{\alpha,V} \cdot \psi_{h,V}$						
Size		M8	M10	M12	M16	M20	M24	
$V_{Rd,c}^o$	Non-cracked concrete	[kN]	6,2	8,9	11,5	15,9	20,8	30,1
	Cracked concrete	[kN]	4,4	6,3	8,2	11,3	14,7	21,4

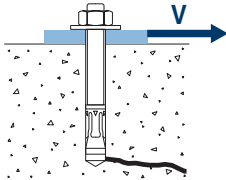



MTP

Coefficients of influence

Influence of concrete strength in concrete edge failure Ψ_b								
		M8	M10	M12	M16	M20	M24	
Ψ_b	C 20/25	1,00						
	C 30/37	1,22						
	C 40/50	1,41						
	C 50/60	1,55						

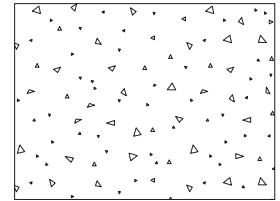

$$\Psi_b = \sqrt{\frac{f_{ck,cube}}{25}} \geq 1$$

Influence of edge distance and spacing $\Psi_{se,V}$																		
FOR ONE ANCHOR ONLY																		
c/h_{ef}	0,50	0,75	1,00	1,25	1,50	1,75	2,00	2,25	2,50	2,75	3,00	3,25	3,50	3,75	4,00	4,50	5,00	
Isolated	0,35	0,65	1,00	1,40	1,84	2,32	2,83	3,38	3,95	4,56	5,20	5,86	6,55	7,26	8,00	9,55	11,18	
FOR TWO ANCHORS																		
c/h_{ef}	0,50	0,75	1,00	1,25	1,50	1,75	2,00	2,25	2,50	2,75	3,00	3,25	3,50	3,75	4,00	4,50	5,00	
s/c	1,0	0,24	0,43	0,67	0,93	1,22	1,54	1,89	2,25	2,64	3,04	3,46	3,91	4,37	4,84	5,33	6,36	7,45
	1,5	0,27	0,49	0,75	1,05	1,38	1,74	2,12	2,53	2,96	3,42	3,90	4,39	4,91	5,45	6,00	7,16	8,39
	2,0	0,29	0,54	0,83	1,16	1,53	1,93	2,36	2,81	3,29	3,80	4,33	4,88	5,46	6,05	6,67	7,95	9,32
	2,5	0,32	0,60	0,92	1,28	1,68	2,12	2,59	3,09	3,62	4,18	4,76	5,37	6,00	6,66	7,33	8,75	10,25
	$\geq 3,0$	0,35	0,65	1,00	1,40	1,84	2,32	2,83	3,38	3,95	4,56	5,20	5,86	6,55	7,26	8,00	9,55	11,18

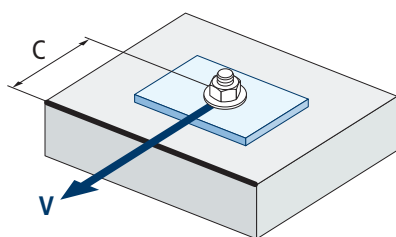

$$\Psi_{se,V} = \left(\frac{c}{h_{ef}}\right)^{1,5}$$

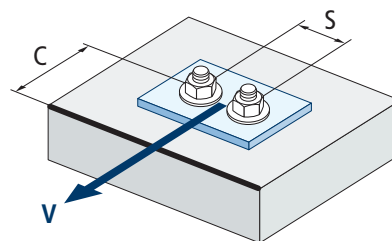

$$\Psi_{se,V} = \left(\frac{c}{h_{ef}}\right)^{1,5} \cdot \left(1 + \frac{s}{3 \cdot c}\right) \cdot 0,5 \leq \left(\frac{c}{h_{ef}}\right)^{1,5}$$



MTP

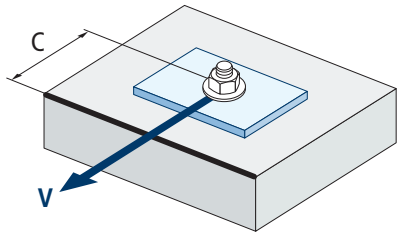

$$\psi_{c,v} = \left(\frac{d}{c} \right)^{0,20}$$

Influence of concrete edge distance $\psi_{c,v}$						
c [mm]	MTP					
	M8	M10	M12	M16	M20	M24
40						
45						
50	0,69					
55	0,68					
60	0,67	0,70				
65	0,66	0,69	0,71			
70	0,65	0,68	0,70			
80	0,63	0,66	0,68			
85	0,62	0,65	0,68	0,72		
90	0,62	0,64	0,67	0,71		
100	0,60	0,63	0,65	0,69	0,72	
105	0,60	0,62	0,65	0,69	0,72	
110	0,59	0,62	0,64	0,68	0,71	
120	0,58	0,61	0,63	0,67	0,70	
125	0,58	0,60	0,63	0,66	0,69	0,72
130	0,57	0,60	0,62	0,66	0,69	0,71
135	0,57	0,59	0,62	0,65	0,68	0,71
140	0,56	0,59	0,61	0,65	0,68	0,70
150	0,56	0,58	0,60	0,64	0,67	0,69
160	0,55	0,57	0,60	0,63	0,66	0,68
170	0,54	0,57	0,59	0,62	0,65	0,68
175	0,54	0,56	0,59	0,62	0,65	0,67
180	0,54	0,56	0,58	0,62	0,64	0,67
190	0,53	0,55	0,58	0,61	0,64	0,66
200	0,53	0,55	0,57	0,60	0,63	0,65
210	0,52	0,54	0,56	0,60	0,62	0,65
220	0,52	0,54	0,56	0,59	0,62	0,64
230	0,51	0,53	0,55	0,59	0,61	0,64
240	0,51	0,53	0,55	0,58	0,61	0,63
250	0,50	0,53	0,54	0,58	0,60	0,63
260	0,50	0,52	0,54	0,57	0,60	0,62
270	0,49	0,52	0,54	0,57	0,59	0,62
280	0,49	0,51	0,53	0,56	0,59	0,61
290	0,49	0,51	0,53	0,56	0,59	0,61
300	0,48	0,51	0,53	0,56	0,58	0,60

Influence of reinforcements $\Psi_{re,v}$

	Without perimetral reinforcements	Perimetral reinforcements $\geq \text{Ø}12$ mm	Perimetral reinforcements with brackets ≤ 100 mm
Non-cracked concrete	1	1	1
Cracked concrete	1	1,2	1,4

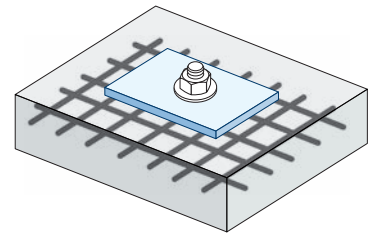
Influence of load application angle $\Psi_{\alpha,v}$

Angle, α (°)	0°	10°	20°	30°	40°	50°	60°	70°	80°	90°
$\Psi_{\alpha,v}$	1,00	1,01	1,05	1,13	1,24	1,40	1,64	1,97	2,32	2,50

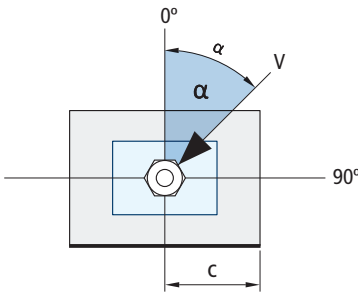

$$\Psi_{\alpha,v} = \sqrt{\frac{1}{(\cos \alpha_v)^2 + \left(\frac{\sin \alpha_v}{2,5}\right)^2}} \geq 1$$

Influence of base material thickness $\Psi_{h,v}$

	MTP									
h/c	0,15	0,30	0,45	0,60	0,75	0,90	1,05	1,20	1,35	$\geq 1,5$
$\Psi_{h,v}$	0,32	0,45	0,55	0,63	0,71	0,77	0,84	0,89	0,95	1,00

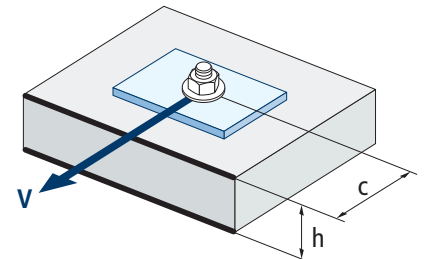

$$\Psi_{h,v} = \left(\frac{h}{1,5 \cdot c}\right)^{0,5} \geq 1,0$$



MTP

FIRE RESISTANCE

Characteristic Resistance*												
	TENSION						SHEAR					
	M8	M10	M12	M16	M20	M24	M8	M10	M12	M16	M20	M24
RF30	0,4	0,9	1,7	3,1	4,9	7,1	0,4	0,9	1,7	3,1	4,9	7,1
RF60	0,3	0,8	1,3	2,4	3,7	5,3	0,3	0,8	1,3	2,4	3,7	5,3
RF90	0,3	0,6	1,1	2,0	3,2	4,6	0,3	0,6	1,1	2,0	3,2	4,5
RF120	0,2	0,5	0,8	1,6	2,5	3,5	0,2	0,5	0,8	1,6	2,5	3,5

*The safety factor for design resistance under fire exposure is $\gamma_{M,fi}=1$ (in absence of other national regulations). As a result the Characteristic Resistance is the same as Design Resistance.

Maximum Load Recommended												
	TENSION						SHEAR					
	M8	M10	M12	M16	M20	M24	M8	M10	M12	M16	M20	M24
RF30	0,3	0,6	1,2	2,2	3,5	5,1	0,3	0,6	1,2	2,2	3,5	5,1
RF60	0,2	0,6	0,9	1,7	2,6	3,8	0,2	0,6	0,9	1,7	2,6	3,8
RF90	0,2	0,4	0,8	1,4	2,3	3,3	0,2	0,4	0,8	1,4	2,3	3,2
RF120	0,1	0,4	0,6	1,1	1,8	2,5	0,1	0,4	0,6	1,1	1,8	2,5

RANGE

Code	Seismic assessment	Size	Maximum thickness of fixture	Axle letter (length)			Code	Seismic assessment	Size	Maximum thickness of fixture	Axle letter (length)		
• AP08050	-	M8 x 50 Ø8	2	A	100	800	AP12120	C1&C2	M12 x 120 Ø12	24	G	50	200
AP08075	-	M8 x 75 Ø8	9	C	100	600	AP12130	C1&C2	M12 x 130 Ø12	34	H	50	200
AP08095	-	M8 x 95 Ø8	29	E	100	600	AP12150	C1&C2	M12 x 150 Ø12	54	I	50	100
AP08115	-	M8 x 115 Ø8	49	G	100	400	AP12180	C1&C2	M12 x 180 Ø12	84	L	50	150
AP10090	C1	M10 x 90 Ø10	10	E	100	400	AP12200	C1&C2	M12 x 200 Ø12	104	M	50	150
AP10105	C1	M10 x 105 Ø10	25	F	50	300	AP16145	C1&C2	M16 x 145 Ø16	28	I	25	100
AP10115	C1	M10 x 115 Ø10	35	G	50	200	AP16175	C1&C2	M16 x 175 Ø16	58	K	25	50
AP10135	C1	M10 x 135 Ø10	55	H	50	200	AP16220	C1&C2	M16 x 220 Ø16	103	O	25	50
AP10165	C1	M10 x 165 Ø10	85	K	50	200	AP16250	C1&C2	M16 x 250 Ø16	133	Q	25	50
AP10185	C1	M10 x 185 Ø10	105	L	50	150	AP20170	-	M20 x 170 Ø20	32	K	20	40
• AP12080	-	M12 x 80 Ø12	4	D	50	300	AP20200	-	M20 x 200 Ø20	62	M	20	40
AP12100	C1&C2	M12 x 100 Ø12	4	E	50	200	AP24205	-	M24 x 205 Ø24	35	N	10	30
AP12110	C1&C2	M12 x 110 Ø12	14	F	50	200	AP24235	-	M24 x 235 Ø24	65	P	10	20

• Non assessed sizes. Resistance values and installation data are not applicable to these references. For further information, please contact Technical Department.



Through-bolt expansion anchor with controlled torque, for use in cracked and non cracked concrete

MTP-X

ETA Assessed Option 1. Zinc-plated shaft. Sherardized clip.

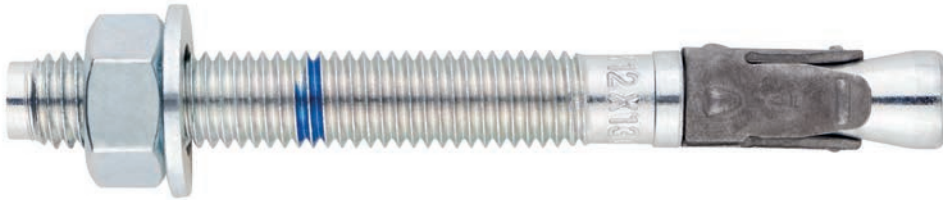

PRODUCT INFORMATION

DESCRIPTION

Metallic anchor, with male thread, expansion by controlled torque.

OFFICIAL DOCUMENTATION

- AVCP-1219-CPR-0053.
- ETA 12/0397 option 1.
- Declaration of Performance DoP MTP.

SIZES

M8x50 to M20x200.

DESIGN LOAD RANGE

From 5,00 to 33,3 kN [non-cracked].
From 3,3 to 20,0 kN [cracked].



BASE MATERIAL

Concrete class from C20/25 to C50/60
cracked or non-cracked.



Stone



Concrete



Reinforced Concrete

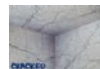

Cracked concrete

ASSESSMENTS

- Option 1 [Cracked or non-cracked concrete].
- Fire Resistance R30-120
- Seismic C1 M8÷M20
- Seismic C2 M10, M12 and M20



12
Técnicas Expansivas S.L.
Segador 13. Logroño. Spain
ETA 12/0397
1219
Structural fixings in concrete

FIRE
RESISTANCESEISMIC
C2 & C1

CHARACTERISTICS AND BENEFITS

- Easy installation.
- Use in cracked and non-cracked concrete.
- Use for medium-heavy duty loads.
- Pre-Installation, or through the drill-hole of the fixture.
- Variety of lengths and diameters: flexibility in assembly.
- For static and quasi-static loads.
- Length mark on top of shaft for easy inspection and quality control.
- Available in INDEXcal.



MATERIALES

Shaft: Carbon steel, zinc plated $\geq 5 \mu\text{m}$.

Washer: DIN 125 or DIN 9021, zinc plated $\geq 5 \mu\text{m}$.

Nut: DIN 934, zinc plated $\geq 5 \mu\text{m}$.

Clip: Carbon steel, sherardized $\geq 40 \mu\text{m}$.



APPLICATIONS

- Anchor plates.
- Metallic structures.
- Bridges.
- Urban fitments.
- Protective fences.
- Catenaries.
- Elevators.
- Pipe supports.

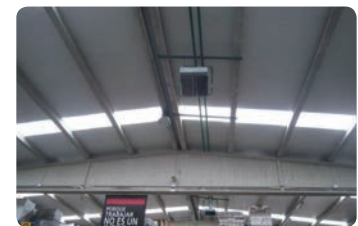



MECHANICAL PROPERTIES

			M8	M10	M12	M16	M20
Cone area section							
A_s	(mm ²)	Cone area section	22,9	41,8	55,4	103,9	176,7
$f_{u,s}$	(N/mm ²)	Characteristic tension resistance	790	750	730	700	660
$f_{y,s}$	(N/mm ²)	Yield strength	632	600	585	560	530
Threaded area section							
A_s	(mm ²)	Cone area section	36,6	58,0	84,3	157,0	245,0
$f_{u,s}$	(N/mm ²)	Characteristic tension resistance	600	600	600	600	600
$f_{y,s}$	(N/mm ²)	Yield Strength	480	480	480	480	480

INSTALLATION DATA

SIZE			M8	M10	M12	M16	M20
Code			APX08XXX	APX10XXX	APX12XXX	APX16XXX	APX20XXX
d_0	Nominal diameter of drill bit	[mm]	8	10	12	16	20
T_{ins}	Installation torque moment	[Nm]	15	40	60	100	200
$d_{f\leq}$	Diameter of clearance hole in the fixture	[mm]	9	12	14	18	22
h_1	Minimum drill hole depth	[mm]	60	75	85	105	125
h_{nom}	Installation depth	[mm]	55	68	80	97	114
h_{ef}	Effective embedment depth	[mm]	48	60	70	85	100
h_{min}	Minimum base material thickness	[mm]	100	120	140	170	200
t_{fix}	Maximum thickness of fixture	[mm]	L - 66	L - 80	L - 96	L - 117	L-138
$s_{cr,N}$	Critical spacing	[mm]	144	180	210	255	300
$c_{cr,N}$	Critical edge distance	[mm]	72	90	105	128	150
$s_{cr,sp}$	Critical distance (splitting)	[mm]	288	300	350	510	600
$c_{cr,sp}$	Critical edge distance (splitting)	[mm]	144	150	175	255	300
s_{min}	Minimum spacing	[mm]	50	60	70	128	150
c_{min}	Minimum edge distance	[mm]	50	60	70	128	150
SW	Installation wrench		13	17	19	24	30

*L = Total anchor length

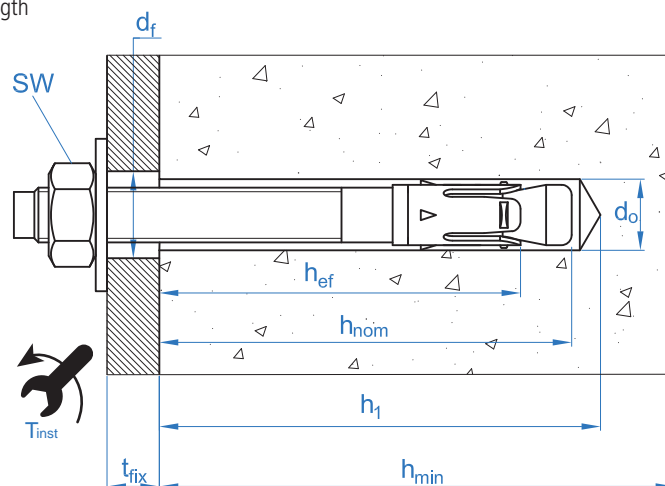



Code	INSTALLATION PRODUCTS
	Hammer drill
BHDSXXXXX	Concrete Drill bits
MOBOMBA	Blow pump
MORCEPKIT	Cleaning Brush
DOMTAXX	Installation hammering tool
	Torque wrench
	Hexagonal socket

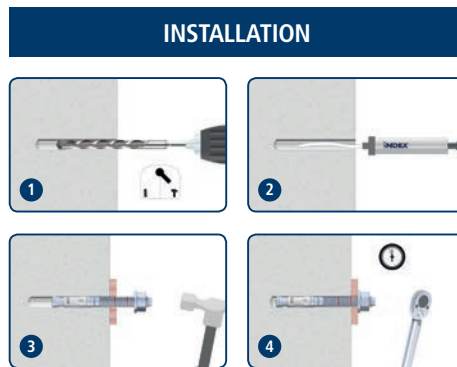

Resistances in C20/25 concrete for an isolated anchor, without effects of edge distance or spacing

Characteristic Resistance N_{Rk} and V_{Rk}													
TENSION							SHEAR						
Size		M8	M10	M12	M16	M20	Size		M8	M10	M12	M16	M20
N_{Rk}	Non-cracked concrete [kN]	9,0	16,0	25,0	35,0	50,0	V_{Rk}	Non-cracked concrete [kN]	11,0	17,4	25,3	47,1	73,1
N_{Rk}	Cracked concrete [kN]	6,0	9,0	16,0	25,0	30,0	V_{Rk}	Cracked concrete [kN]	11,0	17,4	25,3	47,1	73,1

Design Resistance N_{Rd} and V_{Rd}													
TENSION							SHEAR						
Size		M8	M10	M12	M16	M20	Size		M8	M10	M12	M16	M20
N_{Rd}	Non-cracked concrete [kN]	5,0	10,7	16,7	23,3	33,3	V_{Rd}	Non-cracked concrete [kN]	8,8	13,9	20,2	37,7	58,5
N_{Rd}	Cracked concrete [kN]	3,3	6,0	10,7	16,7	20,0	V_{Rd}	Cracked concrete [kN]	8,8	13,9	20,2	37,7	58,5

Maximum Loads Recommended N_{rec} and V_{rec}													
TENSION							SHEAR						
Size		M8	M10	M12	M16	M20	Size		M8	M10	M12	M16	M20
N_{rec}	Non-cracked concrete [kN]	3,6	7,6	11,9	16,7	23,8	V_{rec}	Non-cracked concrete [kN]	6,3	9,9	14,5	26,9	41,8
N_{rec}	Cracked concrete [kN]	2,4	4,3	7,6	11,9	14,3	V_{rec}	Cracked concrete [kN]	6,3	9,9	14,5	26,9	41,8

Simplified calculation method

European Technical Assessment ETA 12/0397

Simplified version of the calculation method according to ETAG 001, annex C. Resistance is calculated according to the data shown in assessment ETA 12/0397.

- Influence of concrete strength.
- Influence of edge distance.
- Influence of spacing between anchors.
- Influence of reinforcements.
- Influence of base material thickness.
- Influence of load application angle.
- Valid for a group of two anchors.

The calculation method is based on the following simplification: **Different loads do not act on individual anchors, without eccentricity.**



INDEXcal

For a more accurate calculation and to take more constructive provisions into account, we recommend using our calculation program INDEXcal. It may be easily downloaded from our website www.indexfix.com



MTP-X

TENSION LOADS

- Steel design resistance: $N_{Rd,s}$
- Pull-out design resistance: $N_{Rd,p} = N_{Rd,p}^o \cdot \psi_c$
- Concrete cone design resistance: $N_{Rd,c} = N_{Rd,c}^o \cdot \psi_b \cdot \psi_{s,N} \cdot \psi_{c,N} \cdot \psi_{re,N}$
- Concrete splitting design resistance: $N_{Rd,sp} = N_{Rd,c}^o \cdot \psi_b \cdot \psi_{s,sp} \cdot \psi_{c,sp} \cdot \psi_{re,N} \cdot \psi_{h,sp}$

Steel Design resistance						
$N_{Rd,s}$						
Size		M8	M10	M12	M16	M20
N_{Rd}^o	[kN]	12,1	20,9	26,9	48,5	77,7

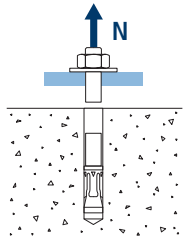

Pull-out design resistance							
$N_{Rd,p} = N_{Rd,p}^o \cdot \psi_c$							
Size		M8	M10	M12	M16	M20	
$N_{Rd,p}^o$	Non-cracked concrete	[kN]	5,0	10,7	16,7	23,3	33,3
$N_{Rd,p}^o$	Cracked concrete	[kN]	3,3	6,0	10,7	16,7	20,0

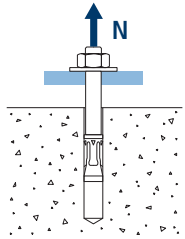

Concrete cone design resistance							
$N_{Rd,c} = N_{Rd,c}^o \cdot \psi_b \cdot \psi_{s,N} \cdot \psi_{c,N} \cdot \psi_{re,N}$							
Concrete splitting design resistance*							
$N_{Rd,sp} = N_{Rd,c}^o \cdot \psi_b \cdot \psi_{s,sp} \cdot \psi_{c,sp} \cdot \psi_{re,N} \cdot \psi_{h,sp}$							
Size		M8	M10	M12	M16	M20	
$N_{Rd,c}^o$	Non-cracked concrete	[kN]	9,3	15,6	19,7	26,4	33,7
$N_{Rd,c}^o$	Cracked concrete	[kN]	6,7	11,2	14,1	18,8	24,0

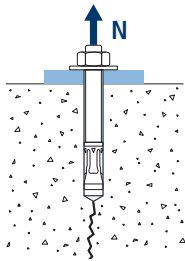
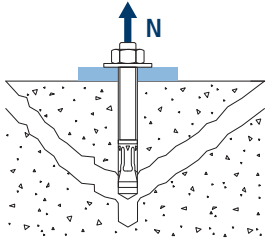

*Concrete splitting design resistance must only be considered for non-cracked concrete.



MTP-X

Coefficients of influence

Influence of concrete strength resistance in pul-out failure Ψ_c

		M8	M10	M12	M16	M20
Ψ_c	C 20/25	1,00	1,00	1,00	1,00	1,00
	C 30/37	1,22	1,16	1,22	1,22	1,16
	C 40/50	1,41	1,31	1,41	1,41	1,31
	C 50/60	1,55	1,41	1,55	1,55	1,41

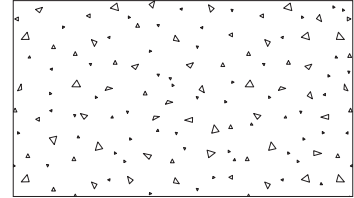
Influence of concrete strength in concret cone and splitting failure Ψ_b

		M8	M10	M12	M16	M20
Ψ_b	C 20/25	1,00				
	C 30/37	1,22				
	C 40/50	1,41				
	C 50/60	1,55				

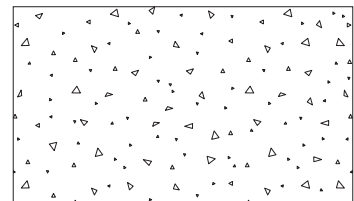

$$\Psi_b = \sqrt{\frac{f_{ck,cube}}{25}} \geq 1$$



MTP-X

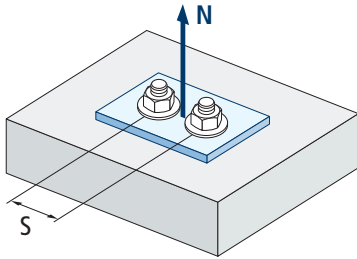

$$\psi_{s,N} = 0,5 + \frac{s}{2 \cdot s_{cr,N}} \leq 1$$

Influence of spacing (concrete cone) $\psi_{s,N}$					
s [mm]	MTP-X				
	M8	M10	M12	M16	M20
50	0,67				
55	0,69				
60	0,71	0,67			
65	0,73	0,68			
70	0,74	0,69	0,67		
80	0,78	0,72	0,69		
85	0,80	0,74	0,70		
90	0,81	0,75	0,71		
100	0,85	0,78	0,74		
105	0,86	0,79	0,75		
110	0,88	0,81	0,76		
120	0,92	0,83	0,79		
125	0,93	0,85	0,80		
126	0,94	0,85	0,80		
128	0,94	0,86	0,80	0,75	
130	0,95	0,86	0,81	0,75	
135	0,97	0,88	0,82	0,76	
144	1,00	0,90	0,84	0,78	
150		0,92	0,86	0,79	0,75
165		0,96	0,89	0,82	0,78
170		0,97	0,90	0,83	0,78
180		1,00	0,93	0,85	0,80
195			0,96	0,88	0,83
200			0,98	0,89	0,83
210			1,00	0,91	0,85
220				0,93	0,87
225				0,94	0,88
252				0,99	0,92
255				1,00	0,93
260					0,93
300					1,00

Invalid value

Value without reduction = 1



Influence of spacing (concrete splitting) $\psi_{s,sp}$					
s [mm]	MTP-X				
	M8	M10	M12	M16	M20
50	0,59				
55	0,60				
60	0,60	0,60			
65	0,61	0,61			
70	0,62	0,62	0,60		
80	0,64	0,63	0,61		
85	0,65	0,64	0,62		
90	0,66	0,65	0,63		
100	0,67	0,67	0,64		
110	0,69	0,68	0,66		
125	0,72	0,71	0,68		
128	0,72	0,71	0,68	0,63	
135	0,73	0,73	0,69	0,63	
140	0,74	0,73	0,70	0,64	
150	0,76	0,75	0,71	0,65	0,63
160	0,78	0,77	0,73	0,66	0,63
165	0,79	0,78	0,74	0,66	0,64
168	0,79	0,78	0,74	0,66	0,64
180	0,81	0,80	0,76	0,68	0,65
192	0,83	0,82	0,77	0,69	0,66
200	0,85	0,83	0,79	0,70	0,67
210	0,86	0,85	0,80	0,71	0,68
220	0,88	0,87	0,81	0,72	0,68
260	0,95	0,93	0,87	0,75	0,72
288	1,00	0,98	0,91	0,78	0,74
300		1,00	0,93	0,79	0,75
336			0,98	0,83	0,78
350			1,00	0,84	0,79
412				0,90	0,84
425				0,92	0,85
500				0,99	0,92
510				1,00	0,93
560					0,97
600					1,00

MTP-X

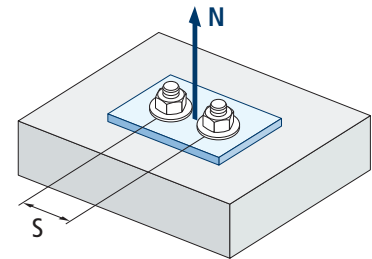

$$\psi_{s,sp} = 0,5 + \frac{s}{2 \cdot s_{cr,sp}} \leq 1$$



MTP-X

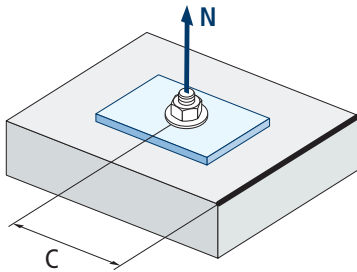

$$\psi_{c,sp} = 0,35 + \frac{0,5 \cdot c}{C_{cr,sp}} + \frac{0,15 \cdot c^2}{C_{cr,sp}^2} \leq 1$$

Influence of concrete edge distance (splitting) $\psi_{c,sp}$					
c [mm]	MTP-X				
	M8	M10	M12	M16	M20
50	0,54				
60	0,58	0,57			
65	0,61	0,59			
70	0,63	0,62	0,57		
75	0,65	0,64	0,59		
80	0,67	0,66	0,61		
83	0,69	0,67	0,62		
84	0,69	0,68	0,62		
85	0,70	0,68	0,63		
90	0,72	0,70	0,65		
96	0,75	0,73	0,67		
100	0,77	0,75	0,68		
105	0,79	0,77	0,70		
110	0,82	0,80	0,72		
125	0,90	0,87	0,78		
128	0,91	0,89	0,80	0,64	
130	0,92	0,90	0,80	0,64	
135	0,95	0,92	0,82	0,66	
144	1,00	0,97	0,86	0,68	
150		1,00	0,89	0,70	0,64
168			0,97	0,74	0,68
175			1,00	0,76	0,69
180			1,02	0,78	0,70
206				0,85	0,76
213				0,87	0,78
250				0,98	0,87
255				1,00	0,88
280					0,95
300					1,00

Value without reduction = 1



Influence of concrete edge distance (concrete cone) $\psi_{c,N}$					
c [mm]	MTP-X				
	M8	M10	M12	M16	M20
50	0,77				
53	0,80				
60	0,87	0,75			
63	0,90	0,77			
65	0,92	0,79			
70	0,98	0,83	0,75		
72	1,00	0,85	0,76		
75		0,87	0,78		
80		0,91	0,82		
83		0,94	0,84		
85		0,96	0,85		
90		1,00	0,89		
98			0,95		
100			0,96		
105			1,00		
110					
113					
125					
126					
128	Value without reduction = 1			1,00	
135					
150					1,00

MTP-X

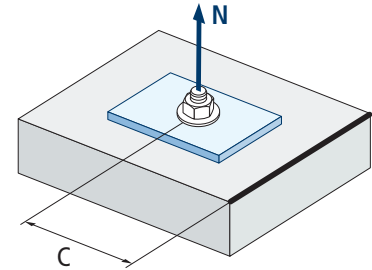

$$\psi_{c,N} = 0,35 + \frac{0,5 \cdot c}{C_{cr,N}} + \frac{0,15 \cdot c^2}{C_{cr,N}^2} \leq 1$$

*The critical concrete edge distance matches the minimum concrete edge distance

Influence of reinforcements $\psi_{re,N}$					
$\psi_{re,N}$	MTP-X				
	M8	M10	M12	M16	M20
	0,74	0,80	0,85	0,93	1,00

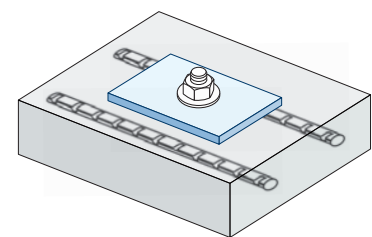

*This factor only applies for a high density of reinforcements. If in the area of the anchor there are reinforcements with a distancing of ≥ 150 mm (any diameter) or with a diameter ≤ 10 mm and a distancing of ≥ 100 mm, a $f_{re,N} = 1$ factor may be applied.

$$\psi_{re,N} = 0,5 + \frac{h_{ef}}{200} \leq 1$$

Influence of base material thickness $\psi_{h,sp}$										
$\psi_{h,sp}$	MTP-X									
	h/h _{ef}	2,00	2,20	2,40	2,60	2,80	3,00	3,20	3,40	3,60
$\psi_{h,sp}$	1,00	1,07	1,13	1,19	1,25	1,31	1,37	1,42	1,48	1,50

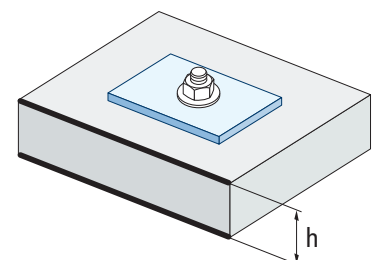

$$\psi_{h,sp} = \left(\frac{h}{2 \cdot h_{ef}} \right)^{2/3} \leq 1,5$$

MTP-X

SHEAR LOADS

- Steel design resistance without lever arm: $V_{Rd,s}$
- Pry-out design resistance: $V_{Rd,cp} = k \cdot N_{Rd,c}^o$
- Concrete edge design resistance: $V_{Rd,c} = V_{Rd,c}^o \cdot \psi_b \cdot \psi_{se,V} \cdot \psi_{c,V} \cdot \psi_{re,V} \cdot \psi_{\alpha,V} \cdot \psi_{h,V}$

Steel design resistance						
$V_{Rd,s}$						
Size		M8	M10	M12	M16	M20
$V_{Rd,s}$	[kN]	8,8	13,9	20,2	37,7	58,5

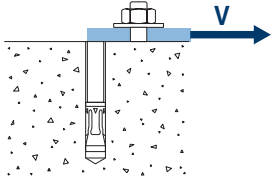

Pry-out design resistance*						
$V_{Rd,cp} = k \cdot N_{Rd,c}^o$						
Size		M8	M10	M12	M16	M20
k		1	2	2	2	2

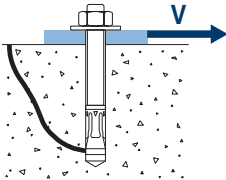

* $N_{Rd,c}^o$ Concrete cone design resistance for tension loads

Concrete edge resistance							
$V_{Rd,c} = V_{Rd,c}^o \cdot \psi_b \cdot \psi_{se,V} \cdot \psi_{c,V} \cdot \psi_{re,V} \cdot \psi_{\alpha,V} \cdot \psi_{h,V}$							
Size		M8	M10	M12	M16	M20	
$V_{Rd,c}^o$	Non-cracked concrete	[kN]	6,2	8,9	11,5	15,9	20,8
	Cracked concrete	[kN]	4,4	6,3	8,2	11,3	14,7

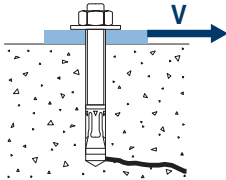



MTP-X

Coefficients of influence

Influence of concrete strength in concrete edge failure Ψ_b						
		M8	M10	M12	M16	M20
Ψ_b	C 20/25	1,00				
	C 30/37	1,22				
	C 40/50	1,41				
	C 50/60	1,55				

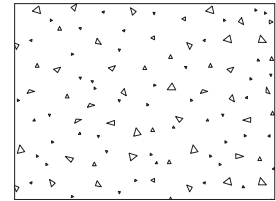

$$\Psi_b = \sqrt{\frac{f_{ck,cube}}{25}} \geq 1$$

Influence of edge distance and spacing $\Psi_{se,V}$																		
FOR ONE ANCHOR ONLY																		
c/h_{ef}	0,50	0,75	1,00	1,25	1,50	1,75	2,00	2,25	2,50	2,75	3,00	3,25	3,50	3,75	4,00	4,50	5,00	
Isolated	0,35	0,65	1,00	1,40	1,84	2,32	2,83	3,38	3,95	4,56	5,20	5,86	6,55	7,26	8,00	9,55	11,18	
FOR TWO ANCHORS																		
c/h_{ef}	0,50	0,75	1,00	1,25	1,50	1,75	2,00	2,25	2,50	2,75	3,00	3,25	3,50	3,75	4,00	4,50	5,00	
s/c	1,0	0,24	0,43	0,67	0,93	1,22	1,54	1,89	2,25	2,64	3,04	3,46	3,91	4,37	4,84	5,33	6,36	7,45
	1,5	0,27	0,49	0,75	1,05	1,38	1,74	2,12	2,53	2,96	3,42	3,90	4,39	4,91	5,45	6,00	7,16	8,39
	2,0	0,29	0,54	0,83	1,16	1,53	1,93	2,36	2,81	3,29	3,80	4,33	4,88	5,46	6,05	6,67	7,95	9,32
	2,5	0,32	0,60	0,92	1,28	1,68	2,12	2,59	3,09	3,62	4,18	4,76	5,37	6,00	6,66	7,33	8,75	10,25
	$\geq 3,0$	0,35	0,65	1,00	1,40	1,84	2,32	2,83	3,38	3,95	4,56	5,20	5,86	6,55	7,26	8,00	9,55	11,18

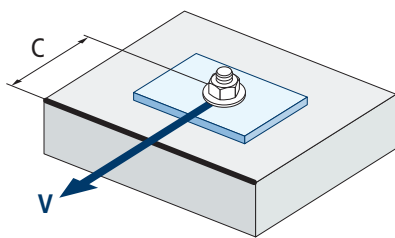

$$\Psi_{se,V} = \left(\frac{c}{h_{ef}}\right)^{1,5}$$

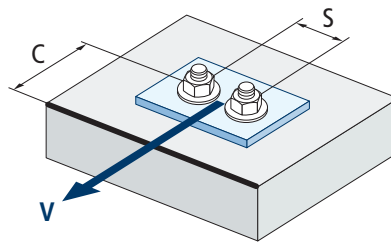

$$\Psi_{se,V} = \left(\frac{c}{h_{ef}}\right)^{1,5} \cdot \left(1 + \frac{s}{3 \cdot c}\right) \cdot 0,5 \leq \left(\frac{c}{h_{ef}}\right)^{1,5}$$



MTP-X

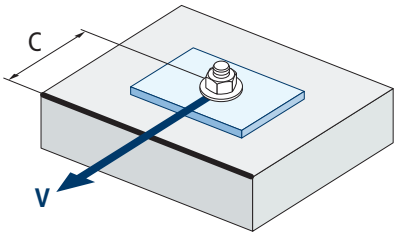

$$\psi_{c,v} = \left(\frac{d}{c} \right)^{0,20}$$

Influence of concrete edge distance $\psi_{c,v}$					
c [mm]	MTP-X				
	M8	M10	M12	M16	M20
40					
45					
50	0,69				
55	0,68				
60	0,67	0,70			
65	0,66	0,69	0,71		
70	0,65	0,68	0,70		
80	0,63	0,66	0,68		
85	0,62	0,65	0,68	0,72	
90	0,62	0,64	0,67	0,71	
100	0,60	0,63	0,65	0,69	0,72
105	0,60	0,62	0,65	0,69	0,72
110	0,59	0,62	0,64	0,68	0,71
120	0,58	0,61	0,63	0,67	0,70
125	0,58	0,60	0,63	0,66	0,69
130	0,57	0,60	0,62	0,66	0,69
135	0,57	0,59	0,62	0,65	0,68
140	0,56	0,59	0,61	0,65	0,68
150	0,56	0,58	0,60	0,64	0,67
160	0,55	0,57	0,60	0,63	0,66
170	0,54	0,57	0,59	0,62	0,65
175	0,54	0,56	0,59	0,62	0,65
180	0,54	0,56	0,58	0,62	0,64
190	0,53	0,55	0,58	0,61	0,64
200	0,53	0,55	0,57	0,60	0,63
210	0,52	0,54	0,56	0,60	0,62
220	0,52	0,54	0,56	0,59	0,62
230	0,51	0,53	0,55	0,59	0,61
240	0,51	0,53	0,55	0,58	0,61
250	0,50	0,53	0,54	0,58	0,60
260	0,50	0,52	0,54	0,57	0,60
270	0,49	0,52	0,54	0,57	0,59
280	0,49	0,51	0,53	0,56	0,59
290	0,49	0,51	0,53	0,56	0,59
300	0,48	0,51	0,53	0,56	0,58

Influence of reinforcements $\Psi_{re,v}$

	Without perimetral reinforcements	Perimetral reinforcements $\geq \text{Ø}12$ mm	Perimetral reinforcements with brackets ≤ 100 mm
Non-cracked concrete	1	1	1
Cracked concrete	1	1,2	1,4

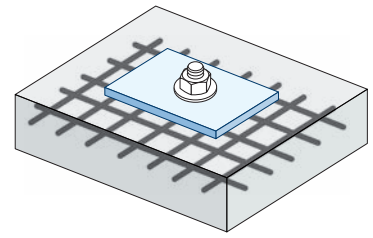
Influence of load application angle $\Psi_{\alpha,v}$

Angle, α (°)	0°	10°	20°	30°	40°	50°	60°	70°	80°	90°
$\Psi_{\alpha,v}$	1,00	1,01	1,05	1,13	1,24	1,40	1,64	1,97	2,32	2,50

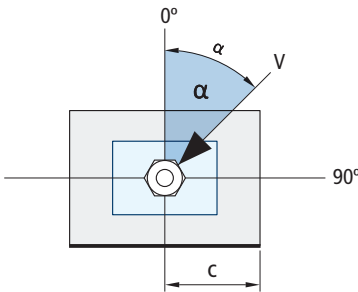

$$\Psi_{\alpha,v} = \sqrt{\frac{1}{(\cos \alpha_v)^2 + \left(\frac{\sin \alpha_v}{2,5}\right)^2}} \geq 1$$

Influence of base material thickness $\Psi_{h,v}$

	MTP-X									
h/c	0,15	0,30	0,45	0,60	0,75	0,90	1,05	1,20	1,35	$\geq 1,5$
$\Psi_{h,v}$	0,32	0,45	0,55	0,63	0,71	0,77	0,84	0,89	0,95	1,00

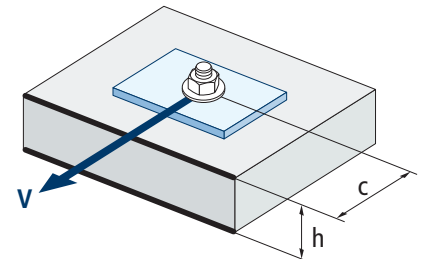

$$\Psi_{h,v} = \left(\frac{h}{1,5 \cdot c}\right)^{0,5} \geq 1,0$$



MTP-X

FIRE RESISTANCE

Characteristic Resistance*										
	TENSION					SHEAR				
	M8	M10	M12	M16	M20	M8	M10	M12	M16	M20
RF30	0,4	0,9	1,7	3,1	4,9	0,4	0,9	1,7	3,1	4,9
RF60	0,3	0,8	1,3	2,4	3,7	0,3	0,8	1,3	2,4	3,7
RF90	0,3	0,6	1,1	2,0	3,2	0,3	0,6	1,1	2,0	3,2
RF120	0,2	0,5	0,8	1,6	2,5	0,2	0,5	0,8	1,6	2,5

*The safety factor for design resistance under fire exposure is $\gamma_{M,fi}=1$ (in absence of other national regulations). As a result the Characteristic Resistance is the same as Design Resistance.

Maximum Load Recommended										
	TENSION					SHEAR				
	M8	M10	M12	M16	M20	M8	M10	M12	M16	M20
RF30	0,3	0,6	1,2	2,2	3,5	0,3	0,6	1,2	2,2	3,5
RF60	0,2	0,6	0,9	1,7	2,6	0,2	0,6	0,9	1,7	2,6
RF90	0,2	0,4	0,8	1,4	2,3	0,2	0,4	0,8	1,4	2,3
RF120	0,1	0,4	0,6	1,1	1,8	0,1	0,4	0,6	1,1	1,8

RANGE

Code	Seismic assessment	Size	Maximum thickness of fixture	Axle letter (length)			Code	Seismic assessment	Size	Maximum thickness of fixture	Axle letter (length)		
• APX08050	-	M8 x 50 Ø8	2	A	100	800	APX12120	C1&C2	M12 x 120 Ø12	24	G	50	200
APX08075	C1	M8 x 75 Ø8	9	C	100	600	APX12130	C1&C2	M12 x 130 Ø12	34	H	50	200
APX08080	C1	M8 x 80 Ø8	14	D	100	600	APX12150	C1&C2	M12 x 150 Ø12	54	I	50	100
APX08095	C1	M8 x 95 Ø8	29	E	100	600	APX12180	C1&C2	M12 x 180 Ø12	84	L	50	150
APX08115	C1	M8 x 115 Ø8	49	G	100	400	APX12200	C1&C2	M12 x 200 Ø12	104	M	50	150
APX10090	C1&C2	M10 x 90 Ø10	10	E	100	400	APX12220	C1&C2	M12 x 220 Ø12	124	O	25	50
APX10105	C1&C2	M10 x 105 Ø10	25	F	50	300	APX12255	C1&C2	M12 x 255 Ø12	159	R	25	50
APX10115	C1&C2	M10 x 115 Ø10	35	G	50	200	APX16145	C1	M16 x 145 Ø16	28	I	25	100
APX10135	C1&C2	M10 x 135 Ø10	55	H	50	200	APX16175	C1	M16 x 175 Ø16	58	K	25	50
APX10165	C1&C2	M10 x 165 Ø10	85	K	50	200	APX16220	C1	M16 x 220 Ø16	103	O	25	50
APX10185	C1&C2	M10 x 185 Ø10	105	L	50	150	APX16250	C1	M16 x 250 Ø16	133	Q	25	50
• APX12080	-	M12 x 80 Ø12	4	D	50	300	APX20170	C1&C2	M20 x 170 Ø20	32	K	20	40
APX12100	C1&C2	M12 x 100 Ø12	4	E	50	200	APX20200	C1&C2	M20 x 200 Ø20	62	M	20	40
APX12110	C1&C2	M12 x 110 Ø12	14	F	50	200							

• Non assessed sizes. Resistance values and installation data are not applicable to these references. For further information, please contact Technical Department.



Through-bolt expansion anchor with controlled torque, for use in cracked and non cracked concrete

MTP-G

ETA Assessed option 1. Sherardized shaft. A4 Stainless clip.



PRODUCT INFORMATION

DESCRIPTION

Metallic anchor, with male thread, expansion by controlled torque.

OFFICIAL DOCUMENTATION

- AVCP-1219-CPR-0053.
- ETA 12/0397 option 1.
- Declaration of Performance DoP MTP.

SIZES

M8x50 to M20x200.

DESIGN LOAD RANGE

From 5,00 to 33,3 kN [non-cracked].
From 3,3 to 20,0 kN [cracked].



BASE MATERIAL

Concrete class from C20/25 to C50/60
cracked or non-cracked.



Stone



Concrete



Reinforced Concrete



Cracked Concrete

ASSESSMENTS

- Option 1 [Cracked and non-cracked concrete].
- Fire Resistance R30-120.



12
Técnicas Expansivas S.L.
Segador 13. Logroño. Spain
ETA 12/0397
1219
Structural fixings in concrete



CHARACTERISTICS AND BENEFITS

- Easy installation.
- Use in cracked and non-cracked concrete.
- Use for medium-heavy duty loads.
- Pre-installation or through the drill-hole of the fixture.
- Variety of lengths and diameters: flexibility in assembly.
- For static and quasi-static loads.
- Available at INDEXcal.



MATERIALS

Shaft: Carbon steel, sherardized $\geq 40 \mu\text{m}$.

Washer: DIN 125 or DIN 9021, sherardized $\geq 40 \mu\text{m}$.

Nut: DIN 934, sherardized $\geq 40 \mu\text{m}$.

Clip: A4 Stainless steel



APPLICATIONS

- Anchor plates.
- Metallic structures.
- Bridges.
- Urban fitments.
- Protective fences.
- Catenaries.
- Elevators.
- Pipe supports.





MECHANICAL PROPERTIES

			M8	M10	M12	M16	M20
Cone area section							
A_s	(mm ²)	Cone area section	22,9	41,8	55,4	103,9	176,7
$f_{u,s}$	(N/mm ²)	Characteristic tension resistance	790	750	730	700	660
$f_{y,s}$	(N/mm ²)	Yield strength	632	600	585	560	530
Threaded area section							
A_s	(mm ²)	Cone area section	36,6	58,0	84,3	157,0	245,0
$f_{u,s}$	(N/mm ²)	Characteristic tension resistance	600	600	600	600	600
$f_{y,s}$	(N/mm ²)	Yield Strength	480	480	480	480	480

INSTALLATION DATA

SIZE			M8	M10	M12	M16	M20
Code			APG08XXX	APG10XXX	APG12XXX	APG16XXX	APG20XXX
d_0	Nominal diameter of drill bit	[mm]	8	10	12	16	20
T_{ins}	Installation torque moment	[Nm]	15	40	60	100	200
$d_{f\leq}$	Diameter of clearance hole in the fixture	[mm]	9	12	14	18	22
h_1	Minimum drill hole depth	[mm]	60	75	85	105	125
h_{nom}	Installation depth	[mm]	55	68	80	97	114
h_{ef}	Effective embedment depth	[mm]	48	60	70	85	100
h_{min}	Minimum base material thickness	[mm]	100	120	140	170	200
t_{fix}	Maximum thickness of fixture	[mm]	L - 66	L - 80	L - 96	L - 117	L-138
$s_{cr,N}$	Critical spacing	[mm]	144	180	210	255	300
$c_{cr,N}$	Critical edge distance	[mm]	72	90	105	128	150
$s_{cr,sp}$	Critical distance (splitting)	[mm]	288	300	350	510	600
$c_{cr,sp}$	Critical edge distance (splitting)	[mm]	144	150	175	255	300
s_{min}	Minimum spacing	[mm]	50	60	70	128	150
c_{min}	Minimum edge distance	[mm]	50	60	70	128	150
SW	Installation wrench		13	17	19	24	30

*L = Total anchor length

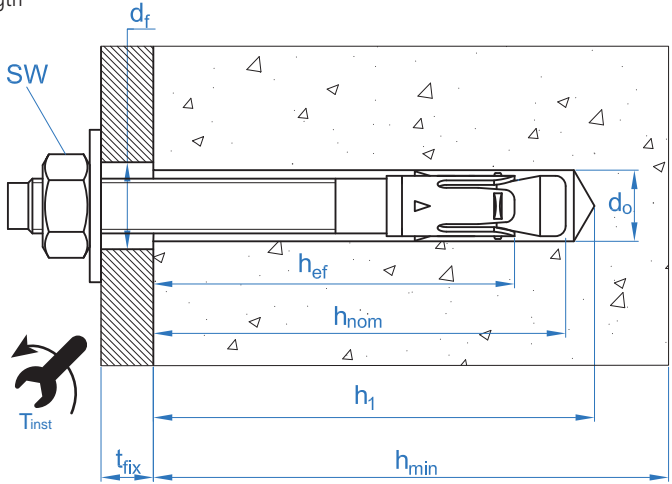



Code	INSTALLATION PRODUCTS
	Hammer drill
BHDSXXXXX	Concrete Drill bits
MOBOMBA	Blow pump
MORCEPKIT	Cleaning Brush
DOMTAXX	Installation hammering tool
	Torque wrench
	Hexagonal socket

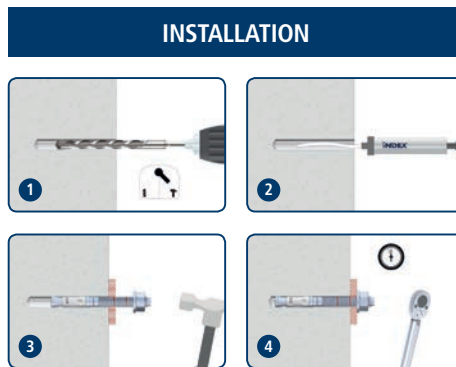

MTP-G

Resistances in C20/25 concrete for an isolated anchor, without effects of edge distance or spacing

Characteristic Resistance N_{Rk} and V_{Rk}													
TENSION							SHEAR						
Size		M8	M10	M12	M16	M20	Size		M8	M10	M12	M16	M20
N_{Rk}	Non-cracked concrete [kN]	9,0	16,0	30,0	35,0	50,0	V_{Rk}	Non-cracked concrete [kN]	11,0	17,4	25,3	47,1	73,1
N_{Rk}	Cracked concrete [kN]	6,0	9,0	16,0	25,0	30,0	V_{Rk}	Cracked concrete [kN]	11,0	17,4	25,3	47,1	73,1

Design Resistance N_{Rd} and V_{Rd}													
TENSION							SHEAR						
Size		M8	M10	M12	M16	M20	Size		M8	M10	M12	M16	M20
N_{Rd}	Non-cracked concrete [kN]	5,0	10,7	20,0	23,3	33,3	V_{Rd}	Non-cracked concrete [kN]	8,8	13,9	20,2	37,7	58,5
N_{Rd}	Cracked concrete [kN]	3,3	6,0	10,7	16,7	20,0	V_{Rd}	Cracked concrete [kN]	8,8	13,9	20,2	37,7	58,5

Maximum Loads Recommended N_{rec} and V_{rec}													
TENSION							SHEAR						
Size		M8	M10	M12	M16	M20	Size		M8	M10	M12	M16	M20
N_{rec}	Non-cracked concrete [kN]	3,6	7,6	14,3	16,7	23,8	V_{rec}	Non-cracked concrete [kN]	6,3	9,9	14,5	26,9	41,8
N_{rec}	Cracked concrete [kN]	2,4	4,3	7,6	11,9	14,3	V_{rec}	Cracked concrete [kN]	6,3	9,9	14,5	26,9	41,8

Simplified calculation method

European Technical Assessment ETA 12/0397

Simplified version of the calculation method according to ETAG 001, annex C. Resistance is calculated according to the data shown in assessment ETA 12/0397.

- Influence of concrete strength.
- Influence of edge distance.
- Influence of spacing between anchors.
- Influence of reinforcements.
- Influence of base material thickness.
- Influence of load application angle.
- Valid for a group of two anchors.

The calculation method is based on the following simplification: **Different loads do not act on individual anchors, without eccentricity.**



INDEXcal

For a more accurate calculation and to take more constructive provisions into account, we recommend using our calculation program INDEXcal. It may be easily downloaded from our website www.indexfix.com



MTP-G

TENSION LOADS

- Steel design resistance: $N_{Rd,s}$
- Pull-out design resistance: $N_{Rd,p} = N_{Rd,p}^o \cdot \Psi_c$
- Concrete cone design resistance: $N_{Rd,c} = N_{Rd,c}^o \cdot \Psi_b \cdot \Psi_{s,N} \cdot \Psi_{c,N} \cdot \Psi_{re,N}$
- Concrete splitting design resistance: $N_{Rd,sp} = N_{Rd,c}^o \cdot \Psi_b \cdot \Psi_{s,sp} \cdot \Psi_{c,sp} \cdot \Psi_{re,N} \cdot \Psi_{h,sp}$

Steel Design resistance						
$N_{Rd,s}$						
Size		M8	M10	M12	M16	M20
N_{Rd}^o	[kN]	12,1	20,9	26,9	48,5	77,7

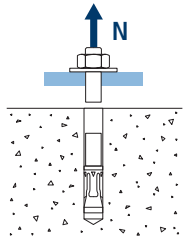

Pull-out design resistance							
$N_{Rd,p} = N_{Rd,p}^o \cdot \Psi_c$							
Size		M8	M10	M12	M16	M20	
$N_{Rd,p}^o$	Non-cracked concrete	[kN]	5,0	10,7	20,0	23,3	33,3
$N_{Rd,p}^o$	Cracked concrete	[kN]	3,3	6,0	10,7	16,7	20,0

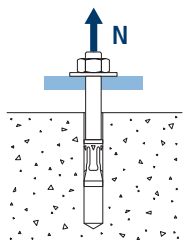

Concrete cone design resistance							
$N_{Rd,c} = N_{Rd,c}^o \cdot \Psi_b \cdot \Psi_{s,N} \cdot \Psi_{c,N} \cdot \Psi_{re,N}$							
Concrete splitting design resistance*							
$N_{Rd,sp} = N_{Rd,c}^o \cdot \Psi_b \cdot \Psi_{s,sp} \cdot \Psi_{c,sp} \cdot \Psi_{re,N} \cdot \Psi_{h,sp}$							
Size		M8	M10	M12	M16	M20	
$N_{Rd,c}^o$	Non-cracked concrete	[kN]	9,3	15,6	19,7	26,4	33,7
$N_{Rd,c}^o$	Cracked concrete	[kN]	6,7	11,2	14,1	18,8	24,0

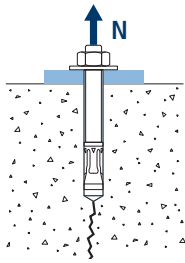
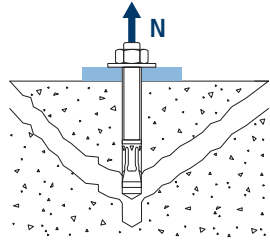

*Concrete splitting design resistance must only be considered for non-cracked concrete.



MTP-G

Coefficients of influence

Influence of concrete strength resistance in pul-out failure Ψ_c

		M8	M10	M12	M16	M20
Ψ_c	C 20/25	1,00	1,00	1,00	1,00	1,00
	C 30/37	1,22	1,16	1,22	1,22	1,16
	C 40/50	1,41	1,31	1,41	1,41	1,31
	C 50/60	1,55	1,41	1,55	1,55	1,41

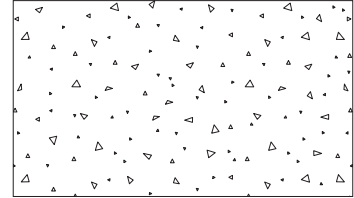
Influence of concrete strength in concret cone and splitting failure Ψ_b

		M8	M10	M12	M16	M20
Ψ_b	C 20/25	1,00				
	C 30/37	1,22				
	C 40/50	1,41				
	C 50/60	1,55				

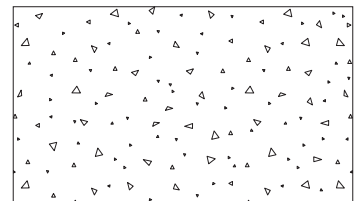

$$\Psi_b = \sqrt{\frac{f_{ck,cube}}{25}} \geq 1$$



MTP-G

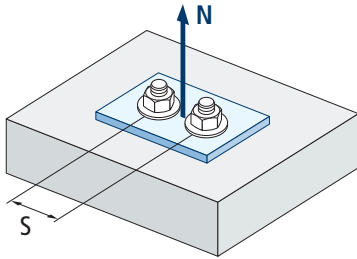

$$\psi_{s,N} = 0,5 + \frac{s}{2 \cdot s_{cr,N}} \leq 1$$

Influence of spacing (concrete cone) $\psi_{s,N}$					
s [mm]	MTP-G				
	M8	M10	M12	M16	M20
50	0,67				
55	0,69				
60	0,71	0,67			
65	0,73	0,68			
70	0,74	0,69	0,67		
80	0,78	0,72	0,69		
85	0,80	0,74	0,70		
90	0,81	0,75	0,71		
100	0,85	0,78	0,74		
105	0,86	0,79	0,75		
110	0,88	0,81	0,76		
120	0,92	0,83	0,79		
125	0,93	0,85	0,80		
126	0,94	0,85	0,80		
128	0,94	0,86	0,80	0,75	
130	0,95	0,86	0,81	0,75	
135	0,97	0,88	0,82	0,76	
144	1,00	0,90	0,84	0,78	
150		0,92	0,86	0,79	0,75
165		0,96	0,89	0,82	0,78
170		0,97	0,90	0,83	0,78
180		1,00	0,93	0,85	0,80
195			0,96	0,88	0,83
200			0,98	0,89	0,83
210			1,00	0,91	0,85
220				0,93	0,87
225				0,94	0,88
252				0,99	0,92
255				1,00	0,93
260					0,93
300					1,00

Invalid value

Value without reduction = 1



Influence of spacing (concrete splitting) $\psi_{s,sp}$					
s [mm]	MTP-G				
	M8	M10	M12	M16	M20
50	0,59				
55	0,60				
60	0,60	0,60			
65	0,61	0,61			
70	0,62	0,62	0,60		
80	0,64	0,63	0,61		
85	0,65	0,64	0,62		
90	0,66	0,65	0,63		
100	0,67	0,67	0,64		
110	0,69	0,68	0,66		
125	0,72	0,71	0,68		
128	0,72	0,71	0,68	0,63	
135	0,73	0,73	0,69	0,63	
140	0,74	0,73	0,70	0,64	
150	0,76	0,75	0,71	0,65	0,63
160	0,78	0,77	0,73	0,66	0,63
165	0,79	0,78	0,74	0,66	0,64
168	0,79	0,78	0,74	0,66	0,64
180	0,81	0,80	0,76	0,68	0,65
192	0,83	0,82	0,77	0,69	0,66
200	0,85	0,83	0,79	0,70	0,67
210	0,86	0,85	0,80	0,71	0,68
220	0,88	0,87	0,81	0,72	0,68
260	0,95	0,93	0,87	0,75	0,72
288	1,00	0,98	0,91	0,78	0,74
300		1,00	0,93	0,79	0,75
336			0,98	0,83	0,78
350			1,00	0,84	0,79
412				0,90	0,84
425				0,92	0,85
500				0,99	0,92
510				1,00	0,93
560					0,97
600					1,00

MTP-G

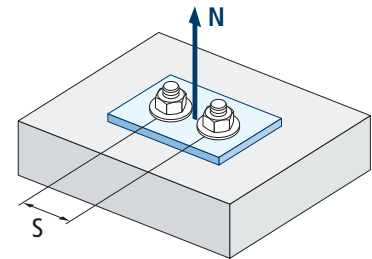

$$\psi_{s,sp} = 0,5 + \frac{s}{2 \cdot s_{cr,sp}} \leq 1$$



MTP-G

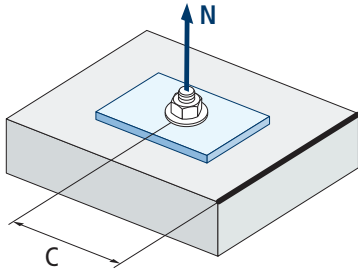

$$\psi_{c,sp} = 0,35 + \frac{0,5 \cdot c}{C_{cr,sp}} + \frac{0,15 \cdot c^2}{C_{cr,sp}^2} \leq 1$$

Influence of concrete edge distance (splitting) $\psi_{c,sp}$					
c [mm]	MTP-G				
	M8	M10	M12	M16	M20
50	0,54				
60	0,58	0,57			Invalid value
65	0,61	0,59			
70	0,63	0,62	0,57		
75	0,65	0,64	0,59		
80	0,67	0,66	0,61		
83	0,69	0,67	0,62		
84	0,69	0,68	0,62		
85	0,70	0,68	0,63		
90	0,72	0,70	0,65		
96	0,75	0,73	0,67		
100	0,77	0,75	0,68		
105	0,79	0,77	0,70		
110	0,82	0,80	0,72		
125	0,90	0,87	0,78		
128	0,91	0,89	0,80	0,64	
130	0,92	0,90	0,80	0,64	
135	0,95	0,92	0,82	0,66	
144	1,00	0,97	0,86	0,68	
150		1,00	0,89	0,70	0,64
168			0,97	0,74	0,68
175			1,00	0,76	0,69
180			1,02	0,78	0,70
206				0,85	0,76
213				0,87	0,78
250				0,98	0,87
255				1,00	0,88
280					0,95
300					1,00

Value without reduction = 1



Influence of concrete edge distance (concrete cone) $\psi_{c,N}$					
c [mm]	MTP-G				
	M8	M10	M12	M16	M20
50	0,77				
53	0,80				
60	0,87	0,75			
63	0,90	0,77			
65	0,92	0,79			
70	0,98	0,83	0,75		
72	1,00	0,85	0,76		
75		0,87	0,78		
80		0,91	0,82		
83		0,94	0,84		
85		0,96	0,85		
90		1,00	0,89		
98			0,95		
100			0,96		
105			1,00		
110					
113					
125					
126					
128	Value without reduction = 1			1,00	
135					
150					1,00

MTP-G

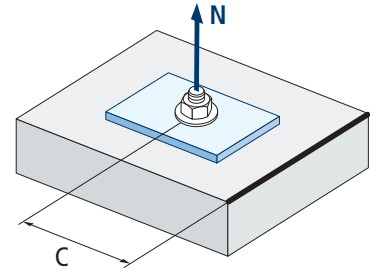

$$\psi_{c,N} = 0,35 + \frac{0,5 \cdot c}{c_{cr,N}} + \frac{0,15 \cdot c^2}{c_{cr,N}^2} \leq 1$$

*The critical concrete edge distance matches the minimum concrete edge distance

Influence of reinforcements $\psi_{re,N}$					
$\psi_{re,N}$	MTP-G				
	M8	M10	M12	M16	M20
	0,74	0,80	0,85	0,93	1,00

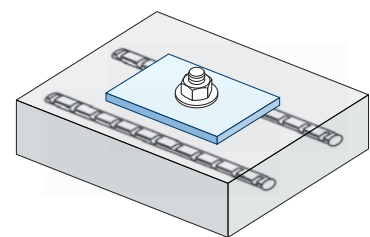

*This factor only applies for a high density of reinforcements. If in the area of the anchor there are reinforcements with a distancing of ≥ 150 mm (any diameter) or with a diameter ≤ 10 mm and a distancing of ≥ 100 mm, a $f_{re,N} = 1$ factor may be applied.

$$\psi_{re,N} = 0,5 + \frac{h_{ef}}{200} \leq 1$$

Influence of base material thickness $\psi_{h,sp}$											
$\psi_{h,sp}$	MTP-G										
	h/h _{ef}	2,00	2,20	2,40	2,60	2,80	3,00	3,20	3,40	3,60	$\geq 3,68$
	$\psi_{h,sp}$	1,00	1,07	1,13	1,19	1,25	1,31	1,37	1,42	1,48	1,50

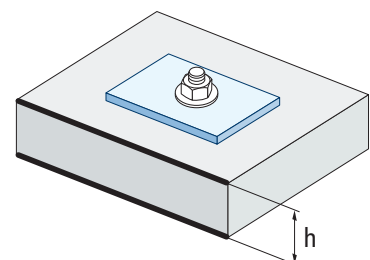

$$\psi_{h,sp} = \left(\frac{h}{2 \cdot h_{ef}} \right)^{2/3} \leq 1,5$$

MTP-G

SHEAR LOADS

- Steel design resistance without lever arm: $V_{Rd,s}$
- Pry-out design resistance: $V_{Rd,cp} = k \cdot N_{Rd,c}^o$
- Concrete edge design resistance: $V_{Rd,c} = V_{Rd,c}^o \cdot \psi_b \cdot \psi_{se,V} \cdot \psi_{c,V} \cdot \psi_{re,V} \cdot \psi_{\alpha,V} \cdot \psi_{h,V}$

Steel design resistance						
$V_{Rd,s}$						
Size		M8	M10	M12	M16	M20
$V_{Rd,s}$	[kN]	8,8	13,9	20,2	37,7	58,5

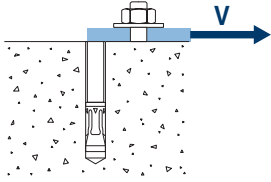

Pry-out design resistance*					
$V_{Rd,cp} = k \cdot N_{Rd,c}^o$					
Size	M8	M10	M12	M16	M20
k	1	2	2	2	2

* $N_{Rd,c}^o$ Concrete cone design resistance for tension loads

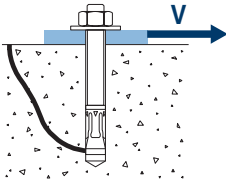

Concrete edge resistance							
$V_{Rd,c} = V_{Rd,c}^o \cdot \psi_b \cdot \psi_{se,V} \cdot \psi_{c,V} \cdot \psi_{re,V} \cdot \psi_{\alpha,V} \cdot \psi_{h,V}$							
Size	M8	M10	M12	M16	M20		
$V_{Rd,c}^o$	Non-cracked concrete	[kN]	6,2	8,9	11,5	15,9	20,8
	Cracked concrete	[kN]	4,4	6,3	8,2	11,3	14,7

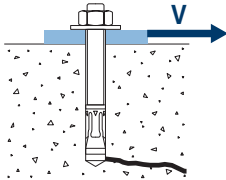



MTP-G

Coefficients of influence

Influence of concrete strength in concrete edge failure Ψ_b						
		M8	M10	M12	M16	M20
Ψ_b	C 20/25	1,00				
	C 30/37	1,22				
	C 40/50	1,41				
	C 50/60	1,55				

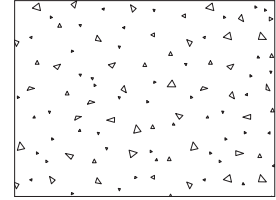

$$\Psi_b = \sqrt{\frac{f_{ck,cube}}{25}} \geq 1$$

Influence of edge distance and spacing $\Psi_{se,V}$																		
FOR ONE ANCHOR ONLY																		
c/h_{ef}	0,50	0,75	1,00	1,25	1,50	1,75	2,00	2,25	2,50	2,75	3,00	3,25	3,50	3,75	4,00	4,50	5,00	
Isolated	0,35	0,65	1,00	1,40	1,84	2,32	2,83	3,38	3,95	4,56	5,20	5,86	6,55	7,26	8,00	9,55	11,18	
FOR TWO ANCHORS																		
c/h_{ef}	0,50	0,75	1,00	1,25	1,50	1,75	2,00	2,25	2,50	2,75	3,00	3,25	3,50	3,75	4,00	4,50	5,00	
s/c	1,0	0,24	0,43	0,67	0,93	1,22	1,54	1,89	2,25	2,64	3,04	3,46	3,91	4,37	4,84	5,33	6,36	7,45
	1,5	0,27	0,49	0,75	1,05	1,38	1,74	2,12	2,53	2,96	3,42	3,90	4,39	4,91	5,45	6,00	7,16	8,39
	2,0	0,29	0,54	0,83	1,16	1,53	1,93	2,36	2,81	3,29	3,80	4,33	4,88	5,46	6,05	6,67	7,95	9,32
	2,5	0,32	0,60	0,92	1,28	1,68	2,12	2,59	3,09	3,62	4,18	4,76	5,37	6,00	6,66	7,33	8,75	10,25
	$\geq 3,0$	0,35	0,65	1,00	1,40	1,84	2,32	2,83	3,38	3,95	4,56	5,20	5,86	6,55	7,26	8,00	9,55	11,18

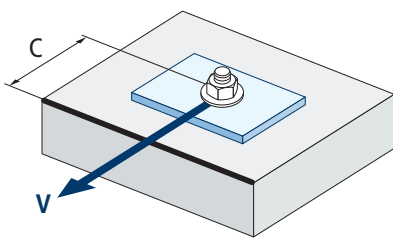

$$\Psi_{se,V} = \left(\frac{c}{h_{ef}}\right)^{1,5}$$

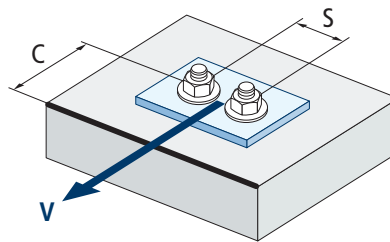

$$\Psi_{se,V} = \left(\frac{c}{h_{ef}}\right)^{1,5} \cdot \left(1 + \frac{s}{3 \cdot c}\right) \cdot 0,5 \leq \left(\frac{c}{h_{ef}}\right)^{1,5}$$



MTP-G

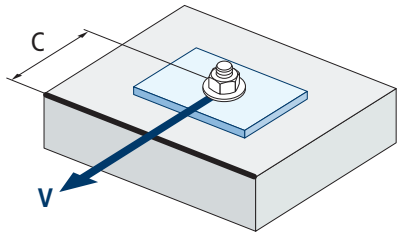

$$\psi_{c,v} = \left(\frac{d}{c} \right)^{0,20}$$

Influence of concrete edge distance $\psi_{c,v}$					
c [mm]	MTP-G				
	M8	M10	M12	M16	M20
40					
45					
50	0,69				
55	0,68				
60	0,67	0,70			
65	0,66	0,69	0,71		
70	0,65	0,68	0,70		
80	0,63	0,66	0,68		
85	0,62	0,65	0,68	0,72	
90	0,62	0,64	0,67	0,71	
100	0,60	0,63	0,65	0,69	0,72
105	0,60	0,62	0,65	0,69	0,72
110	0,59	0,62	0,64	0,68	0,71
120	0,58	0,61	0,63	0,67	0,70
125	0,58	0,60	0,63	0,66	0,69
130	0,57	0,60	0,62	0,66	0,69
135	0,57	0,59	0,62	0,65	0,68
140	0,56	0,59	0,61	0,65	0,68
150	0,56	0,58	0,60	0,64	0,67
160	0,55	0,57	0,60	0,63	0,66
170	0,54	0,57	0,59	0,62	0,65
175	0,54	0,56	0,59	0,62	0,65
180	0,54	0,56	0,58	0,62	0,64
190	0,53	0,55	0,58	0,61	0,64
200	0,53	0,55	0,57	0,60	0,63
210	0,52	0,54	0,56	0,60	0,62
220	0,52	0,54	0,56	0,59	0,62
230	0,51	0,53	0,55	0,59	0,61
240	0,51	0,53	0,55	0,58	0,61
250	0,50	0,53	0,54	0,58	0,60
260	0,50	0,52	0,54	0,57	0,60
270	0,49	0,52	0,54	0,57	0,59
280	0,49	0,51	0,53	0,56	0,59
290	0,49	0,51	0,53	0,56	0,59
300	0,48	0,51	0,53	0,56	0,58



Influence of reinforcements $\Psi_{re,v}$			
	Without perimetral reinforcements	Perimetral reinforcements $\geq \text{Ø}12 \text{ mm}$	Perimetral reinforcements with brackets $\leq 100 \text{ mm}$
Non-cracked concrete	1	1	1
Cracked concrete	1	1,2	1,4

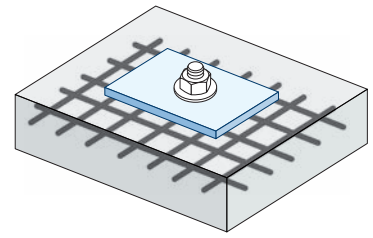

Influence of load application angle $\Psi_{\alpha,v}$											
Angle, $\alpha(^{\circ})$	0°	10°	20°	30°	40°	50°	60°	70°	80°	90°	
$\Psi_{\alpha,v}$	1,00	1,01	1,05	1,13	1,24	1,40	1,64	1,97	2,32	2,50	

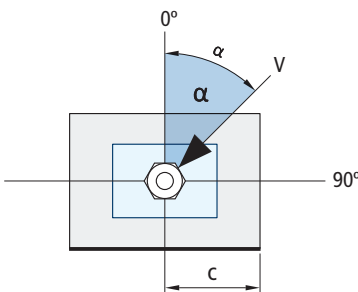

$$\Psi_{\alpha,v} = \sqrt{\frac{1}{(\cos \alpha_v)^2 + \left(\frac{\sin \alpha_v}{2,5}\right)^2}} \geq 1$$

Influence of base material thickness $\Psi_{h,v}$											
MTP-G											
h/c	0,15	0,30	0,45	0,60	0,75	0,90	1,05	1,20	1,35	$\geq 1,5$	
$\Psi_{h,v}$	0,32	0,45	0,55	0,63	0,71	0,77	0,84	0,89	0,95	1,00	

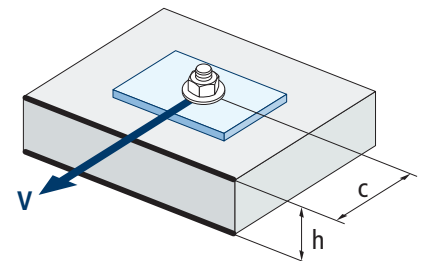

$$\Psi_{h,v} = \left(\frac{h}{1,5 \cdot c}\right)^{0,5} \geq 1,0$$



MTP-G

FIRE RESISTANCE

Characteristic Resistance*										
	TENSION					SHEAR				
	M8	M10	M12	M16	M20	M8	M10	M12	M16	M20
RF30	0,4	0,9	1,7	3,1	4,9	0,4	0,9	1,7	3,1	4,9
RF60	0,3	0,8	1,3	2,4	3,7	0,3	0,8	1,3	2,4	3,7
RF90	0,3	0,6	1,1	2,0	3,2	0,3	0,6	1,1	2,0	3,2
RF120	0,2	0,5	0,8	1,6	2,5	0,2	0,5	0,8	1,6	2,5

*The safety factor for design resistance under fire exposure is $\gamma_{M,fi}=1$ (in absence of other national regulations). As a result the Characteristic Resistance is the same as Design Resistance.

Maximum Load Recommended										
	TENSION					SHEAR				
	M8	M10	M12	M16	M20	M8	M10	M12	M16	M20
RF30	0,3	0,6	1,2	2,2	3,5	0,3	0,6	1,2	2,2	3,5
RF60	0,2	0,6	0,9	1,7	2,6	0,2	0,6	0,9	1,7	2,6
RF90	0,2	0,4	0,8	1,4	2,3	0,2	0,4	0,8	1,4	2,3
RF120	0,1	0,4	0,6	1,1	1,8	0,1	0,4	0,6	1,1	1,8

RANGE

Code	Size	Maximum thickness of fixture	Axle letter (length)			Code	Size	Maximum thickness of fixture	Axle letter (length)		
• APG06060	M6 x 60 Ø6	10	B	200	1.200	APG10185	M10 x 185 Ø10	105	L	50	150
• APG06070	M6 x 70 Ø6	20	C	200	1.200	• APG12080	M12 x 80 Ø12	4	D	50	300
• APG06100	M6 x 100 Ø6	50	E	200	800	APG12110	M12 x 110 Ø12	14	F	50	200
• APG08050	M8 x 50 Ø8	2	A	100	800	APG12130	M12 x 130 Ø12	34	H	50	200
• APG08060	M8 x 60 Ø8	12	B	100	800	APG12150	M12 x 150 Ø12	54	I	50	100
APG08075	M8 x 75 Ø8	9	C	100	600	APG12180	M12 x 180 Ø12	84	L	50	150
APG08095	M8 x 95 Ø8	29	E	100	600	APG12200	M12 x 200 Ø12	104	M	50	150
APG08115	M8 x 115 Ø8	49	G	100	400	APG16125	M16 x 125 Ø16	8	G	25	100
• APG10070	M10 x 70 Ø10	5	C	100	400	APG16145	M16 x 145 Ø16	28	I	25	100
APG10090	M10 x 90 Ø10	10	E	100	400	APG16175	M16 x 175 Ø16	58	K	25	50
APG10105	M10 x 105 Ø10	25	F	50	300	APG16220	M16 x 220 Ø16	103	O	25	50
APG10115	M10 x 115 Ø10	35	G	50	200	APG20170	M20 x 170 Ø20	32	K	20	40
APG10135	M10 x 135 Ø10	55	H	50	200	APG20200	M20 x 200 Ø20	62	M	20	40
APG10165	M10 x 165 Ø10	85	K	50	200						

• Non assessed sizes. Resistance values and installation data are not applicable to these references. For further information, please contact Technical Department.



Through-bolt expansion anchor with controlled torque, for use in cracked and non cracked concrete

MTP-A4

ETA Assessed Option 1. A4 Stainless shaft. A4 Stainless clip.



PRODUCT INFORMATION

DESCRIPTION

Metallic anchor, with male thread, expansion by controlled torque.

OFFICIAL DOCUMENTATION

- AVCP-1404-CPR-2520.
- ETA 15/0145 option 1.
- Declaration of Performance DoP MTP-A4.

SIZES

M8x68 to M16x220.

DESIGN LOAD RANGE

From 6,00 to 23,3 kN [non-cracked].
From 3,3 to 16,67 kN [cracked].



BASE MATERIAL

Concrete class from C20/25 to C50/60
cracked or non-cracked.



Stone



Concrete



Reinforced Concrete



Cracked Concrete

ASSESSMENTS

- Option 1 [Cracked concrete].
- Fire Resistance R30-120
- Seismic C1 M8÷M16.
- Seismic C2 M10÷M16.

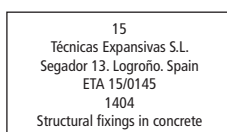
FIRE
RESISTANCESEISMIC
C2 & C1

CHARACTERISTICS AND BENEFITS

- Easy installation.
- Use in cracked and non-cracked concrete.
- Pre-installation or through the drill-hole of the fixture.
- Variety of lengths and diameters: flexibility in assembly.
- For static and quasi-static loads.
- Friction operation. Installation by controlled torque
- Use for medium loads.
- Assessed for fire resistance RF30 to RF120.
- A4 Stainless steel [AISI 316].
- Available at INDEXcal.



MATERIALS

Shaft: A4 Stainless steel.

Washer: DIN 125, A4 Stainless steel.

Nut: DIN 934, A4 Stainless steel.

Clip: A4 Stainless steel.



APPLICATIONS

- Structural fixings in cracked and non cracked concrete, including industrial and marine environments
- Safety barriers.
- Fixings of steel beams, perforated bracker guides, machinery, boilers, signage, staium seating, facade substructures, etc.
- Fixing of wood structures to concrete.





MECHANICAL PROPERTIES

			M8	M10	M12	M16
Cone area section						
A_s	(mm ²)	Cone area section	22,9	41,8	55,4	103,9
$f_{u,s}$	(N/mm ²)	Characteristic tension resistance	790	750	730	700
$f_{y,s}$	(N/mm ²)	Yield strength	632	600	585	560
Threaded area section						
A_s	(mm ²)	Cone area section	36,6	58,0	84,3	157,0
$f_{u,s}$	(N/mm ²)	Characteristic tension resistance	600	600	600	600
$f_{y,s}$	(N/mm ²)	Yield Strength	480	480	480	480

INSTALLATION DATA

SIZE			M8	M10	M12	M16
Code			APA408XXX	APA410XXX	APA412XXX	APA416XXX
d_0	Nominal diameter of drill bit	[mm]	8	10	12	16
T_{ins}	Installation torque moment	[Nm]	20	40	60	120
$d_{f\leq}$	Diameter of clearance hole in the fixture	[mm]	9	12	14	18
h_1	Minimum drill hole depth	[mm]	70	80	100	115
h_{nom}	Installation depth	[mm]	54	67	81	97
h_{ef}	Effective embedment depth	[mm]	48	60	72	86
h_{min}	Minimum base material thickness	[mm]	100	120	150	170
t_{fix}	Maximum thickness of fixture	[mm]	L-65	L-80	L-100	L-120
$s_{cr,N}$	Critical spacing	[mm]	144	180	216	258
$c_{cr,N}$	Critical edge distance	[mm]	72	90	108	129
$s_{cr,sp}$	Critical distance (splitting)	[mm]	144	180	216	258
$c_{cr,sp}$	Critical edge distance (splitting)	[mm]	72	90	108	129
s_{min}	Minimum spacing	[mm]	50	55	60	70
c_{min}	Minimum edge distance	[mm]	50	55	60	70
SW	Installation wrench		13	17	19	24

*L = Total anchor length

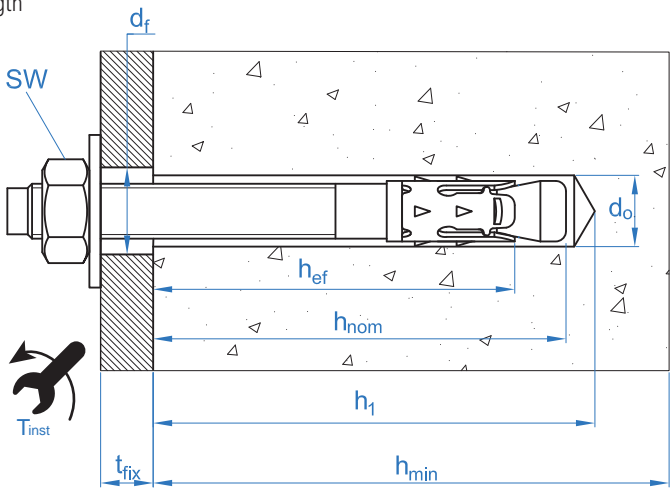



Code	INSTALLATION PRODUCTS
	Hammer drill
BHDSXXXXX	Concrete Drill bits
MOBOMBA	Blow pump
MORCEPKIT	Cleaning Brush
DOMTAXX	Installation hammering tool
	Torque wrench
	Hexagonal socket

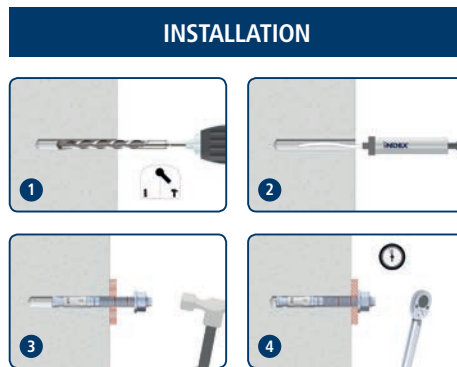

MTP-A4

Resistances in C20/25 concrete for an isolated anchor, without effects of edge distance or spacing

Characteristic Resistance N_{Rk} and V_{Rk}											
TENSION						SHEAR					
Size		M8	M10	M12	M16	Size		M8	M10	M12	M16
N_{Rk}	Non-cracked concrete [kN]	9,0	16,0	20,0	35,0	V_{Rk}	Non-cracked concrete [kN]	11,9	18,8	27,4	51,0
N_{Rk}	Cracked concrete [kN]	5,0	9,0	12,0	25,0	V_{Rk}	Cracked concrete [kN]	11,9	18,8	27,4	51,0

Design Resistance N_{Rd} and V_{Rd}											
TENSION						SHEAR					
Size		M8	M10	M12	M16	Size		M8	M10	M12	M16
N_{Rd}	Non-cracked concrete [kN]	6,0	10,7	13,3	23,3	V_{Rd}	Non-cracked concrete [kN]	9,2	14,5	21,1	39,2
N_{Rd}	Cracked concrete [kN]	3,3	6,0	8,0	16,7	V_{Rd}	Cracked concrete [kN]	9,2	14,5	21,1	39,2

Maximum Loads Recommended N_{rec} and V_{rec}											
TENSION						SHEAR					
Size		M8	M10	M12	M16	Size		M8	M10	M12	M16
N_{rec}	Non-cracked concrete [kN]	4,3	7,6	9,5	16,7	V_{rec}	Non-cracked concrete [kN]	6,5	10,3	15,1	28,0
N_{rec}	Cracked concrete [kN]	2,4	4,3	5,7	11,9	V_{rec}	Cracked concrete [kN]	6,5	10,3	15,1	28,0

Simplified calculation method

European Technical Assessment ETA 15/0145

Simplified version of the calculation method according to ETAG 001, annex C. Resistance is calculated according to the data shown in assessment ETA 15/0145.

- Influence of concrete strength.
- Influence of edge distance.
- Influence of spacing between anchors.
- Influence of reinforcements.
- Influence of base material thickness.
- Influence of load application angle.
- Valid for a group of two anchors.

The calculation method is based on the following simplification: **Different loads do not act on individual anchors, without eccentricity.**



INDEXcal

For a more accurate calculation and to take more constructive provisions into account, we recommend using our calculation program INDEXcal. It may be easily downloaded from our website www.indexfix.com

MTP-A4

TENSION LOADS

- Steel design resistance: $N_{Rd,s}$
- Pull-out design resistance: $N_{Rd,p} = N_{Rd,p}^o \cdot \Psi_c$
- Concrete cone design resistance: $N_{Rd,c} = N_{Rd,c}^o \cdot \Psi_b \cdot \Psi_{s,N} \cdot \Psi_{c,N} \cdot \Psi_{re,N}$
- Concrete splitting design resistance: $N_{Rd,sp} = N_{Rd,c}^o \cdot \Psi_b \cdot \Psi_{s,sp} \cdot \Psi_{c,sp} \cdot \Psi_{re,N} \cdot \Psi_{h,sp}$

Steel Design resistance					
$N_{Rd,s}$					
Size		M8	M10	M12	M16
N_{Rd}^o	[kN]	14,0	22,7	32,7	58,7

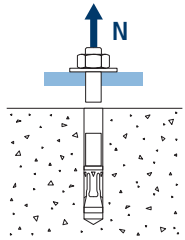

Pull-out design resistance					
$N_{Rd,p} = N_{Rd,p}^o \cdot \Psi_c$					
Size		M8	M10	M12	M16
$N_{Rd,p}^o$	Non-cracked concrete [kN]	6,0	10,7	13,3	23,3
$N_{Rd,p}^o$	Cracked concrete [kN]	3,3	6,0	8,0	16,7

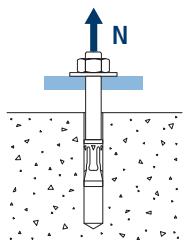

Concrete cone design resistance					
$N_{Rd,c} = N_{Rd,c}^o \cdot \Psi_b \cdot \Psi_{s,N} \cdot \Psi_{c,N} \cdot \Psi_{re,N}$					
Concrete splitting design resistance*					
$N_{Rd,sp} = N_{Rd,c}^o \cdot \Psi_b \cdot \Psi_{s,sp} \cdot \Psi_{c,sp} \cdot \Psi_{re,N} \cdot \Psi_{h,sp}$					
Size		M8	M10	M12	M16
$N_{Rd,c}^o$	Non-cracked concrete [kN]	11,2	15,6	20,6	26,9
$N_{Rd,c}^o$	Cracked concrete [kN]	8,0	11,2	14,7	19,1

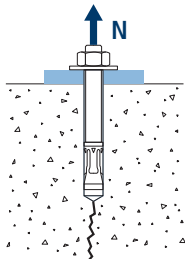
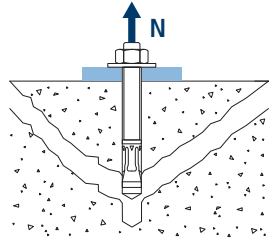

*Concrete splitting design resistance must only be considered for non-cracked concrete.



MTP-A4

Coefficients of influence

Influence of concrete strength resistance in pul-out failure ψ_c

		M8	M10	M12	M16
ψ_c	C 20/25	1,00			
	C 30/37	1,22			
	C 40/50	1,41			
	C 50/60	1,55			

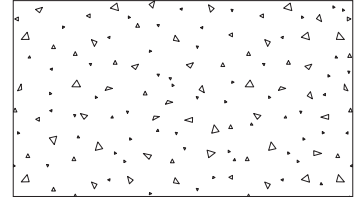
Influence of concrete strength in concret cone and splitting failure ψ_b

		M8	M10	M12	M16
ψ_b	C 20/25	1,00			
	C 30/37	1,22			
	C 40/50	1,41			
	C 50/60	1,55			

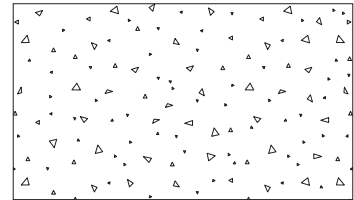

$$\psi_b = \sqrt{\frac{f_{ck,cube}}{25}} \geq 1$$



MTP-A4

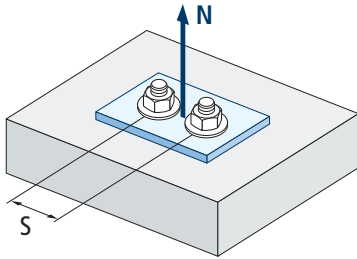

$$\psi_{s,N} = 0,5 + \frac{s}{2 \cdot s_{cr,N}} \leq 1$$

Influence of spacing (concrete cone) $\psi_{s,N}$				
s [mm]	MTP-A4			
	M8	M10	M12	M16
50	0,67			Invalid value
55	0,68	0,67		
60	0,70	0,68	0,67	
65	0,72	0,70	0,68	
70	0,73	0,71	0,69	0,67
80	0,77	0,74	0,72	0,69
85	0,78	0,76	0,74	0,70
90	0,80	0,77	0,75	0,71
100	0,83	0,80	0,78	0,74
105	0,85	0,82	0,79	0,75
110	0,87	0,83	0,81	0,76
120	0,90	0,86	0,83	0,79
125	0,92	0,88	0,85	0,80
126	0,92	0,88	0,85	0,80
128	0,93	0,89	0,86	0,80
130	0,93	0,89	0,86	0,81
135	0,95	0,91	0,88	0,82
144	0,98	0,94	0,90	0,84
150	1,00	0,95	0,92	0,86
165		1,00	0,96	0,89
170			0,97	0,90
180			1,00	0,93
195	Value without reduction = 1			0,96
200				0,98
210				1,00

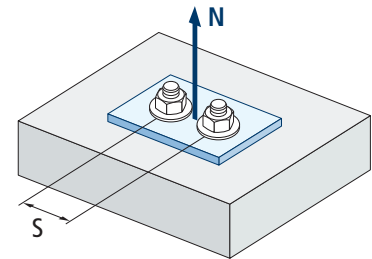

Influence of spacing (concrete splitting) $\psi_{s,sp}$						
s [mm]	MTP-A4					
	M8	M10	M12	M16		
50	0,67	Invalid value				
55	0,68				0,67	
60	0,70				0,68	0,67
65	0,72				0,70	0,68
70	0,73	0,71	0,69	0,67		
80	0,77	0,74	0,72	0,69		
85	0,78	0,76	0,74	0,70		
90	0,80	0,77	0,75	0,71		
100	0,83	0,80	0,78	0,74		
110	0,87	0,83	0,81	0,76		
125	0,92	0,88	0,85	0,80		
128	0,93	0,89	0,86	0,80		
135	0,95	0,91	0,88	0,82		
140	0,97	0,92	0,89	0,83		
150	1,00	0,95	0,92	0,86		
160	Value without reduction = 1		0,98	0,88		
165			1,00	0,89		
168			0,97	0,90		
180			1,00	0,93		
192	Value without reduction = 1			0,96		
200				0,98		
210				1,00		

MTP-A4

$$\psi_{s,sp} = 0,5 + \frac{s}{2 \cdot s_{cr,sp}} \leq 1$$



MTP-A4

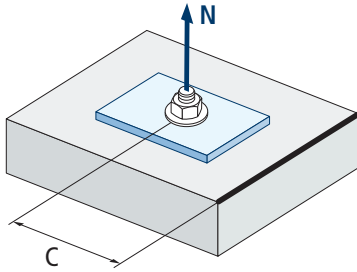

$$\psi_{c,sp} = 0,35 + \frac{0,5 \cdot c}{C_{cr,sp}} + \frac{0,15 \cdot c^2}{C_{cr,sp}^2} \leq 1$$

Influence of concrete edge distance (splitting) $\psi_{c,sp}$				
c [mm]	MTP-A4			
	M8	M10	M12	M16
50	0,75	0,71	Invalid value	
60	0,85	0,79	0,75	
65	0,90	0,84	0,79	
70	0,95	0,88	0,83	0,75
75	1,00	0,93	0,87	0,78
80	Value without reduction = 1		0,91	0,82
83			1,00	0,94
84	Value without reduction = 1		0,95	0,85
85			0,96	0,85
90	Value without reduction = 1		1,00	0,89
96			0,93	
100	Value without reduction = 1		0,96	
105			1,00	



Influence of concrete edge distance (concrete cone) $\psi_{c,N}$				
c [mm]	MTP-A4			
	M8	M10	M12	M16
50	0,75	0,71	Invalid value	
53	0,78	0,73		
60	0,85	0,79		
63	0,88	0,82		
65	0,90	0,84	0,79	Value without reduction = 1
70	0,95	0,88	0,83	
72	0,97	0,90	0,85	
75	1,00	0,93	0,87	
80	1,05	0,98	0,91	
83		1,00	0,94	
85			0,96	
90			1,00	
98				
100				
105				

MTP-A4

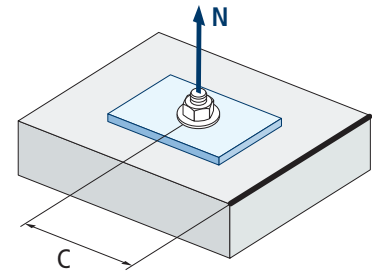

$$\psi_{c,N} = 0,35 + \frac{0,5 \cdot c}{C_{cr,N}} + \frac{0,15 \cdot c^2}{C_{cr,N}^2} \leq 1$$

Influence of reinforcements $\psi_{re,N}$				
$\psi_{re,N}$	MTP-A4			
	M8	M10	M12	M16
	0,74	0,80	0,85	0,93

*This factor only applies for a high density of reinforcements. If in the area of the anchor there are reinforcements with a distancing of ≥ 150 mm (any diameter) or with a diameter ≤ 10 mm and a distancing of ≥ 100 mm, a $f_{re,N} = 1$ factor may be applied.

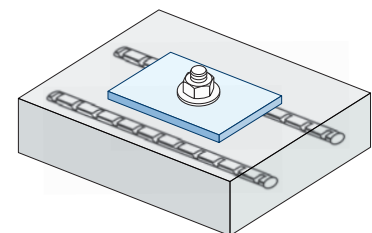

$$\psi_{re,N} = 0,5 + \frac{h_{ef}}{200} \leq 1$$

Influence of base material thickness $\psi_{h,sp}$											
$\psi_{h,sp}$	MTP-A4										
	h/h _{ef}	2,00	2,20	2,40	2,60	2,80	3,00	3,20	3,40	3,60	$\geq 3,68$
	$\psi_{h,sp}$	1,00	1,07	1,13	1,19	1,25	1,31	1,37	1,42	1,48	1,50

$$\psi_{h,sp} = \left(\frac{h}{2 \cdot h_{ef}} \right)^{2/3} \leq 1,5$$

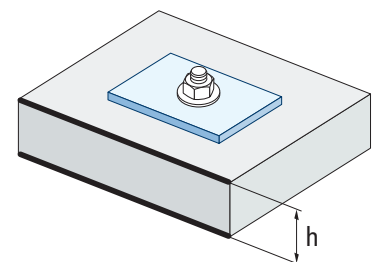



MTP-A4

SHEAR LOADS

- Steel design resistance without lever arm: $V_{Rd,s}$
- Pry-out design resistance: $V_{Rd,cp} = k \cdot N_{Rd,c}^o$
- Concrete edge design resistance: $V_{Rd,c} = V_{Rd,c}^o \cdot \psi_b \cdot \psi_{se,V} \cdot \psi_{c,V} \cdot \psi_{re,V} \cdot \psi_{\alpha,V} \cdot \psi_{h,V}$

Steel design resistance					
$V_{Rd,s}$					
Size		M8	M10	M12	M16
$V_{Rd,s}$	[kN]	9,2	14,5	21,1	39,2

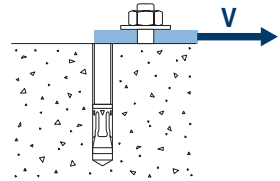

Pry-out design resistance*					
$V_{Rd,cp} = k \cdot N_{Rd,c}^o$					
Size		M8	M10	M12	M16
k		1	2	2	2

* $N_{Rd,c}^o$ Concrete cone design resistance for tension loads

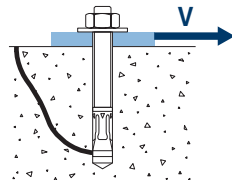

Concrete edge resistance						
$V_{Rd,c} = V_{Rd,c}^o \cdot \psi_b \cdot \psi_{se,V} \cdot \psi_{c,V} \cdot \psi_{re,V} \cdot \psi_{\alpha,V} \cdot \psi_{h,V}$						
Size		M8	M10	M12	M16	
$V_{Rd,c}^o$	Non-cracked concrete	[kN]	6,2	8,9	12,0	16,2
	Cracked concrete	[kN]	4,4	6,3	8,5	11,5

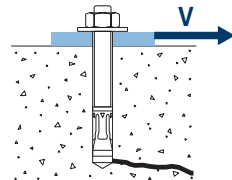



MTP-A4

Coefficients of influence

Influence of concrete strength in concrete edge failure Ψ_b

		M8	M10	M12	M16
Ψ_b	C 20/25	1,00			
	C 30/37	1,22			
	C 40/50	1,41			
	C 50/60	1,55			

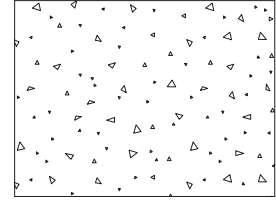

$$\Psi_b = \sqrt{\frac{f_{ck,cube}}{25}} \geq 1$$

Influence of edge distance and spacing $\Psi_{se,V}$

FOR ONE ANCHOR ONLY

c/h_{ef}	0,50	0,75	1,00	1,25	1,50	1,75	2,00	2,25	2,50	2,75	3,00	3,25	3,50	3,75	4,00	4,50	5,00
Isolated	0,35	0,65	1,00	1,40	1,84	2,32	2,83	3,38	3,95	4,56	5,20	5,86	6,55	7,26	8,00	9,55	11,18

FOR TWO ANCHORS

c/h_{ef}	0,50	0,75	1,00	1,25	1,50	1,75	2,00	2,25	2,50	2,75	3,00	3,25	3,50	3,75	4,00	4,50	5,00	
s/c	1,0	0,24	0,43	0,67	0,93	1,22	1,54	1,89	2,25	2,64	3,04	3,46	3,91	4,37	4,84	5,33	6,36	7,45
	1,5	0,27	0,49	0,75	1,05	1,38	1,74	2,12	2,53	2,96	3,42	3,90	4,39	4,91	5,45	6,00	7,16	8,39
	2,0	0,29	0,54	0,83	1,16	1,53	1,93	2,36	2,81	3,29	3,80	4,33	4,88	5,46	6,05	6,67	7,95	9,32
	2,5	0,32	0,60	0,92	1,28	1,68	2,12	2,59	3,09	3,62	4,18	4,76	5,37	6,00	6,66	7,33	8,75	10,25
	≥3,0	0,35	0,65	1,00	1,40	1,84	2,32	2,83	3,38	3,95	4,56	5,20	5,86	6,55	7,26	8,00	9,55	11,18

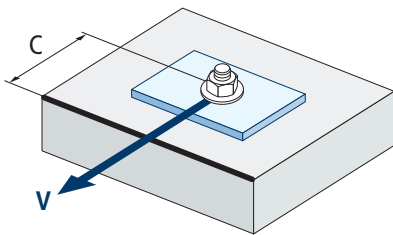

$$\Psi_{se,V} = \left(\frac{c}{h_{ef}}\right)^{1,5}$$

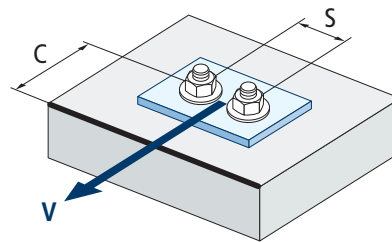

$$\Psi_{se,V} = \left(\frac{c}{h_{ef}}\right)^{1,5} \cdot \left(1 + \frac{s}{3 \cdot c}\right) \cdot 0,5 \leq \left(\frac{c}{h_{ef}}\right)^{1,5}$$



MTP-A4

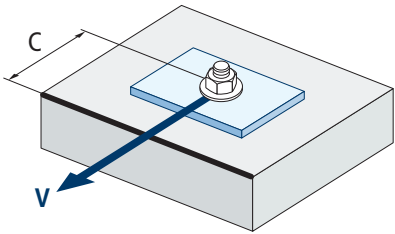

$$\psi_{c,v} = \left(\frac{d}{c} \right)^{0,20}$$

Influence of concrete edge distance $\psi_{c,v}$					
c [mm]	MTP-A4				
	M8	M10	M12	M16	
40					
45					
50	0,69			Invalid value	
55	0,68				
60	0,67	0,70			
65	0,66	0,69	0,71		
70	0,65	0,68	0,70		
80	0,63	0,66	0,68		
85	0,62	0,65	0,68		0,72
90	0,62	0,64	0,67		0,71
100	0,60	0,63	0,65		0,69
105	0,60	0,62	0,65		0,69
110	0,59	0,62	0,64	0,68	
120	0,58	0,61	0,63	0,67	
125	0,58	0,60	0,63	0,66	
130	0,57	0,60	0,62	0,66	
135	0,57	0,59	0,62	0,65	
140	0,56	0,59	0,61	0,65	
150	0,56	0,58	0,60	0,64	
160	0,55	0,57	0,60	0,63	
170	0,54	0,57	0,59	0,62	
175	0,54	0,56	0,59	0,62	
180	0,54	0,56	0,58	0,62	
190	0,53	0,55	0,58	0,61	
200	0,53	0,55	0,57	0,60	
210	0,52	0,54	0,56	0,60	
220	0,52	0,54	0,56	0,59	
230	0,51	0,53	0,55	0,59	
240	0,51	0,53	0,55	0,58	
250	0,50	0,53	0,54	0,58	
260	0,50	0,52	0,54	0,57	
270	0,49	0,52	0,54	0,57	
280	0,49	0,51	0,53	0,56	
290	0,49	0,51	0,53	0,56	
300	0,48	0,51	0,53	0,56	



Influence of reinforcements $\Psi_{re,v}$			
	Without perimetral reinforcements	Perimetral reinforcements $\geq \text{Ø}12$ mm	Perimetral reinforcements with brackets ≤ 100 mm
Non-cracked concrete	1	1	1
Cracked concrete	1	1,2	1,4

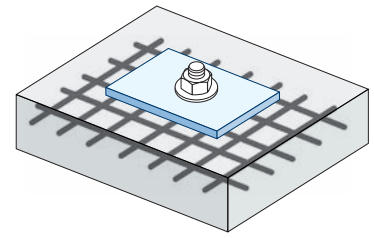

Influence of load application angle $\Psi_{\alpha,v}$											
Angle, $\alpha(^{\circ})$	0°	10°	20°	30°	40°	50°	60°	70°	80°	90°	
$\Psi_{\alpha,v}$	1,00	1,01	1,05	1,13	1,24	1,40	1,64	1,97	2,32	2,50	

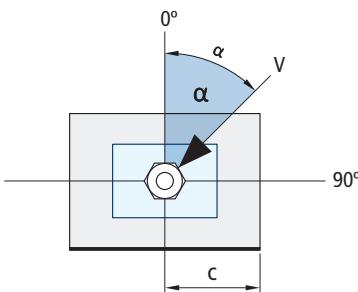

$$\Psi_{\alpha,v} = \sqrt{\frac{1}{(\cos \alpha_v)^2 + \left(\frac{\sin \alpha_v}{2,5}\right)^2}} \geq 1$$

Influence of base material thickness $\Psi_{h,v}$											
MTP-A4											
h/c	0,15	0,30	0,45	0,60	0,75	0,90	1,05	1,20	1,35	$\geq 1,5$	
$\Psi_{h,v}$	0,32	0,45	0,55	0,63	0,71	0,77	0,84	0,89	0,95	1,00	

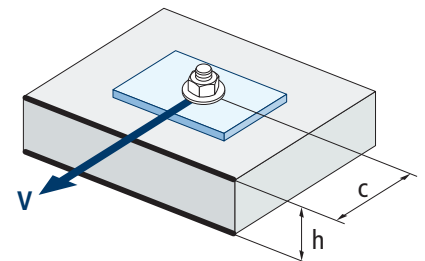

$$\Psi_{h,v} = \left(\frac{h}{1,5 \cdot c}\right)^{0,5} \geq 1,0$$



MTP-A4

FIRE RESISTANCE

Characteristic Resistance*								
	TENSION				SHEAR			
	M8	M10	M12	M16	M8	M10	M12	M16
RF30	0,5	1,1	1,8	3,3	0,7	1,5	2,5	4,7
RF60	0,4	0,9	1,5	2,7	0,6	1,2	2,1	3,9
RF90	0,3	0,7	1,2	2,2	0,4	0,9	1,7	3,1
RF120	0,3	0,6	1,0	1,8	0,4	0,8	1,4	2,5

*The safety factor for design resistance under fire exposure is $\gamma_{M,fi}=1$ (in absence of other national regulations). As a result the Characteristic Resistance is the same as Design Resistance.

Maximum Load Recommended								
	TENSION				SHEAR			
	M8	M10	M12	M16	M8	M10	M12	M16
RF30	0,4	0,8	1,3	2,4	0,5	1,1	1,8	3,4
RF60	0,3	0,6	1,1	1,9	0,4	0,9	1,5	2,8
RF90	0,2	0,5	0,9	1,6	0,3	0,6	1,2	2,2
RF120	0,2	0,4	0,7	1,3	0,3	0,6	1,0	1,8

RANGE

Code	Seismic assessment	Size	Maximum thickness of fixture	Axle letter (length)			Code	Seismic assessment	Size	Maximum thickness of fixture	Axle letter (length)		
APA408068	C1	M8 x 68 Ø8	4	A	100	600	APA410185	C1&C2	M10 x 185 Ø10	105	F	50	100
APA408075	C1	M8 x 75 Ø8	10	B	100	600	APA412110	C1&C2	M12 x 110 Ø12	10	A	50	300
APA408090	C1	M8 x 90 Ø8	25	C	100	600	APA412120	C1&C2	M12 x 120 Ø12	20	B	50	300
APA408115	C1	M8 x 115 Ø8	50	D	100	400	APA412145	C1&C2	M12 x 145 Ø12	45	C	50	200
APA408135	C1	M8 x 135 Ø8	70	E	50	300	APA412170	C1&C2	M12 x 170 Ø12	70	D	50	100
APA408165	C1	M8 x 165 Ø8	100	G	50	200	APA412200	C1&C2	M12 x 200 Ø12	100	E	50	100
APA410090	C1&C2	M10 x 90 Ø10	10	A	100	400	APA416130	C1&C2	M16 x 130 Ø16	10	A	50	100
APA410105	C1&C2	M10 x 105 Ø10	25	B	50	300	APA416150	C1&C2	M16 x 150 Ø16	30	B	25	100
APA410115	C1&C2	M10 x 115 Ø10	35	C	50	300	APA416185	C1&C2	M16 x 185 Ø16	60	C	25	50
APA410135	C1&C2	M10 x 135 Ø10	55	D	50	300	APA416220	C1&C2	M16 x 220 Ø16	100	D	20	40
APA410155	C1&C2	M10 x 155 Ø10	75	E	50	300							



Through-bolt expansion anchor with controlled torque, for use in non cracked concrete

MTH

ETA Assessed Option 7. Zinc-plated shaft. Zinc-plated clip.

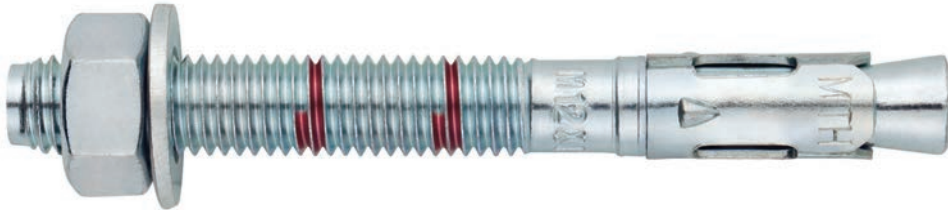

PRODUCT INFORMATION

DESCRIPTION

Metallic anchor, with male thread, expansion by controlled torque.

OFFICIAL DOCUMENTATION

- AVCP-1219-CPR-00063.
- ETA 05/0242 option 7.
- Declaration of Performance DoP MTH.
- MFPA Fire Protection Assessment.

SIZES

M6x60 to M20x270.

DESIGN LOAD RANGE

From 5,3 to 38,3 kN [standard depth].
From 6,7 to 23,8 kN [reduced depth].



BASE MATERIAL

Concrete class from C20/25 to C50/60 non-cracked.



Stone



Concrete



Reinforced concrete

ASSESSMENTS

- Option 7 [Non-cracked concrete].

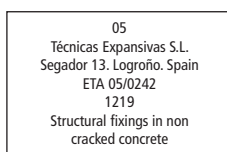
**FIRE**
RESISTANCE

CHARACTERISTICS AND BENEFITS

- Easy installation.
- Use in non-cracked concrete.
- Use for medium-heavy duty loads.
- Pre-installation or through the drill-hole of the fixture.
- Variety of lengths and diameters: flexibility in assembly.
- For static and quasi-static loads.
- Two installation depths in M8, M10, M12, M16 and M20, allowing the use in thick anchor plates or in low thickness base materials.
- Available at INDEXcal.



MATERIALS

Shaft: Cold-formed carbon steel, zinc-plated $\geq 5 \mu\text{m}$.

Washer: DIN 125 or DIN 9021, zinc-plated $\geq 5 \mu\text{m}$.

Nut: DIN 934, zinc-plated $\geq 5 \mu\text{m}$.

Clip: Cold-formed carbon steel, zinc-plated $\geq 40 \mu\text{m}$.



APPLICATIONS

- Anchor plates.
- Supports.
- Structures.
- Shelving
- Urban fitments.
- Protective fences.
- Catenaries.
- Elevators.
- Scaffolding fixing.

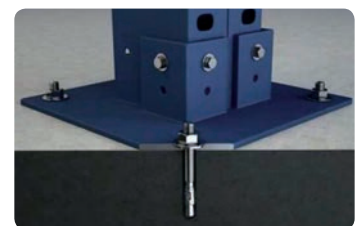



MECHANICAL PROPERTIES

			M6	M8	M10	M12	M14	M16	M20
Cone area section									
A_s	(mm ²)	Cone area section	14,5	25,5	46,5	68,0	100,2	122,6	216,3
$f_{u,s}$	(N/mm ²)	Characteristic tension resistance	510	510	510	490	490	490	460
$f_{y,s}$	(N/mm ²)	Yield strength	440	440	440	410	410	410	375
Threaded area section									
A_s	(mm ²)	Cone area section	20,1	36,6	58,0	84,3	115,0	157,0	245,0
$f_{u,s}$	(N/mm ²)	Characteristic tension resistance	510	510	510	490	490	490	490
$f_{y,s}$	(N/mm ²)	Yield Strength	440	440	440	410	410	410	410

INSTALLATION DATA

SIZE			M6	M8	M10	M12	M14	M16	M20	
Code			AH06XXX	AH08XXX	AH10XXX	AH12XXX	AH14XXX	AH16XXX	AH20XXX	
d_0	Nominal diameter of drill bit	[mm]	6	8	10	12	14	16	20	
T_{ins}	Installation torque moment	[Nm]	7	20	35	60	90	120	240	
$d_f \leq$	Diameter of clearance hole in the fixture	[mm]	7	9	12	14	16	18	22	
Standard depth	h_1	Minimum drill hole depth	[mm]	55	65	75	85	100	110	135
	h_{nom}	Installation depth	[mm]	49,5	59,5	66,5	77	91	103,5	125
	h_{ef}	Effective embedment depth	[mm]	40	48	55	65	75	84	103
	h_{min}	Minimum base material thickness	[mm]	100	100	110	130	150	168	206
	t_{fix}	Maximum thickness of fixture*	[mm]	L - 58	L - 70	L - 80	L - 92	L - 108	L - 122	L - 147
	$s_{cr,N}$	Critical spacing	[mm]	120	144	165	195	225	252	309
	$c_{cr,N}$	Critical edge distance	[mm]	60	72	83	98	113	126	155
	$s_{cr,sp}$	Critical distance (splitting)	[mm]	160	192	220	260	300	280	360
	$c_{cr,sp}$	Critical edge distance (splitting)	[mm]	80	96	110	130	150	140	180
	Reduced depth	h_1	Minimum drill hole depth	[mm]	-	50	60	70	-	90
h_{nom}		Installation depth	[mm]	-	46,5	53,5	62	-	84,5	97
h_{ef}		Effective embedment depth	[mm]	-	35	42	50	-	65	75
h_{min}		Minimum base material thickness	[mm]	-	100	100	100	-	130	150
t_{fix}		Maximum thickness of fixture*	[mm]	-	L-57	L-67	L-77	-	L - 103	L - 121
$s_{cr,N}$		Critical spacing	[mm]	-	105	126	150	-	195	225
$c_{cr,N}$		Critical edge distance	[mm]	-	53	63	75	-	98	113
$s_{cr,sp}$		Critical distance (splitting)	[mm]	-	140	168	200	-	260	300
$c_{cr,sp}$		Critical edge distance (splitting)	[mm]	-	70	84	100	-	130	150
s_{min}		Minimum spacing	[mm]	35	40	50	70	80	90	135
c_{min}	Minimum edge distance	[mm]	35	40	50	70	80	90	135	
SW	Installation wrench		10	13	17	19	22	24	30	

*L = Total anchor length

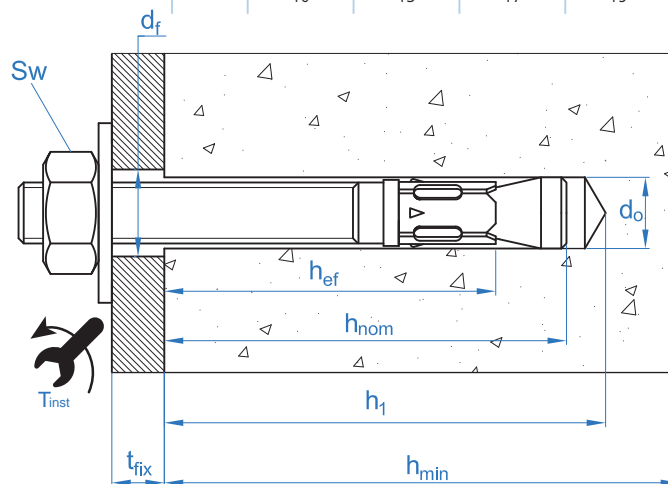



Code	INSTALLATION PRODUCTS
	Hammer drill
BHDSXXXXX	Concrete Drill bits
MOBOMBA	Blow pump
MORCEPKIT	Cleaning Brush
DOMTAXX	Installation hammering tool
	Torque wrench
	Hexagonal socket

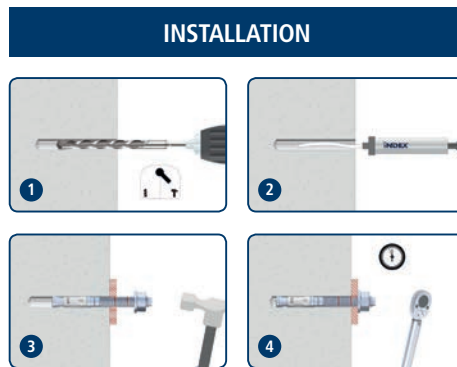

Resistances in C20/25 concrete for an isolated anchor, without effects of edge distance or spacing

Characteristic Resistance N_{Rk} y V_{Rk}																			
TENSION									SHEAR										
Size		M6	M8	M10	M12	M14	M16	M20	Size		M6	M8	M10	M12	M14	M16	M20		
N_{Rk}	Standard depth	[kN]	7,4	13,0	19,0	26,4	32,8	38,8	52,7	V_{Rk}	Standard depth	[kN]	5,1	9,3	14,7	20,6	28,1	38,4	56,3
N_{Rk}	Reduced depth	[kN]	-	10,0	13,7	17,8	-	26,4	32,8	V_{Rk}	Reduced depth	[kN]	-	10,4	13,7	17,8	-	38,4	65,6

Design Resistance N_{Rd} y V_{Rd}																			
TENSION									SHEAR										
Size		M6	M8	M10	M12	M14	M16	M20	Size		M6	M8	M10	M12	M14	M16	M20		
N_{Rd}	Standard depth	[kN]	5,3	9,2	12,7	17,6	21,8	25,9	35,1	V_{Rd}	Standard depth	[kN]	4,1	7,4	11,8	16,4	22,5	30,7	45,1
N_{Rd}	Reduced depth	[kN]	-	6,7	9,1	11,9	-	17,6	21,8	V_{Rd}	Reduced depth	[kN]	-	7,0	9,1	11,9	-	30,7	43,7

Maximum Loads Recommended N_{rec} y V_{rec}																			
TENSION									SHEAR										
Size		M6	M8	M10	M12	M14	M16	M20	Size		M6	M8	M10	M12	M14	M16	M20		
N_{rec}	Standard depth	[kN]	3,8	6,6	9,0	12,6	15,6	18,5	25,1	V_{rec}	Standard depth	[kN]	2,9	5,3	8,4	11,8	16,0	21,9	32,1
N_{rec}	Reduced depth	[kN]	-	4,8	6,5	8,5	-	12,6	15,6	V_{rec}	Reduced depth	[kN]	-	4,9	6,5	8,5	-	21,9	31,2

Simplified calculation method

European Technical Assessment ETA 05/0242

Simplified version of the calculation method according to ETAG 001, annex C. Resistance is calculated according to the data shown in assessment ETA 05/0242.

- Influence of concrete strength.
- Influence of edge distance.
- Influence of spacing between anchors.
- Influence of reinforcements.
- Influence of base material thickness.
- Influence of load application angle.
- Valid for a group of two anchors.



INDEXcal

For a more accurate calculation and to take more constructive provisions into account, we recommend using our calculation program INDEXcal. It may be easily downloaded from our website www.indexfix.com

MTH

TENSION LOADS

- Steel design resistance: $N_{Rd,s}$
- Pull-out design resistance: $N_{Rd,p} = N_{Rd,p}^o \cdot \Psi_c$
- Concrete cone design resistance: $N_{Rd,c} = N_{Rd,c}^o \cdot \Psi_b \cdot \Psi_{s,N} \cdot \Psi_{c,N} \cdot \Psi_{re,N}$
- Concrete splitting design resistance: $N_{Rd,sp} = N_{Rd,c}^o \cdot \Psi_b \cdot \Psi_{s,sp} \cdot \Psi_{c,sp} \cdot \Psi_{re,N} \cdot \Psi_{h,sp}$

Steel Design resistance			$N_{Rd,s}$						
Size			M6	M8	M10	M12	M14	M16	M20
N_{Rd}^o	Standard depth	[kN]	5,3	9,3	16,9	23,8	35,1	42,9	71,1

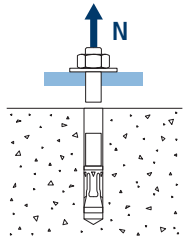

Pull-out design resistance			$N_{Rd,p} = N_{Rd,p}^o \cdot \Psi_c$						
Size			M6	M8	M10	M12	M14	M16	M20
$N_{Rd,p}^o$	Standard depth	[kN]	-*	-*	12,6	-*	-*	-*	-*
$N_{Rd,p}^o$	Reduced depth	[kN]	-	6,6	-*	-*	-	-*	-*

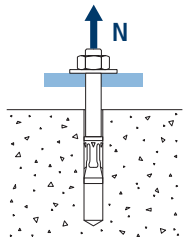

* Pull-out failure is not decisive.

Concrete cone design resistance			$N_{Rd,c} = N_{Rd,c}^o \cdot \Psi_b \cdot \Psi_{s,N} \cdot \Psi_{c,N} \cdot \Psi_{re,N}$						
Concrete splitting design resistance*			$N_{Rd,sp} = N_{Rd,c}^o \cdot \Psi_b \cdot \Psi_{s,sp} \cdot \Psi_{c,sp} \cdot \Psi_{re,N} \cdot \Psi_{h,sp}$						
Size			M6	M8	M10	M12	M14	M16	M20
$N_{Rd,c}^o$	Standard depth	[kN]	8,5	11,2	13,7	17,6	21,8	25,9	35,1
$N_{Rd,c}^o$	Reduced depth	[kN]	-	7,0	9,1	11,9	-	17,6	21,8

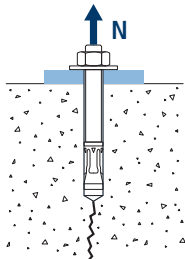
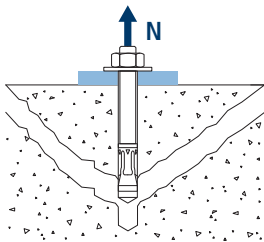

* Concrete splitting design resistance must only be considered for non-cracked concrete.



MTH

Coefficients of influence

Influence of concrete strength resistance in pul-out failure Ψ_c

		M6	M8	M10	M12	M14	M16	M20
Ψ_c	C 20/25	1,00						
	C 30/37	1,22						
	C 40/50	1,41						
	C 50/60	1,55						

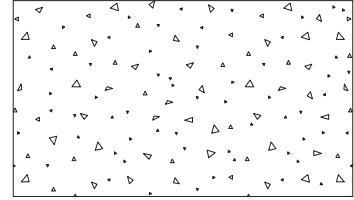
Influence of concrete strength in concret cone and splitting failure Ψ_b

		M6	M8	M10	M12	M14	M16	M20
Ψ_b	C 20/25	1,00						
	C 30/37	1,22						
	C 40/50	1,41						
	C 50/60	1,55						

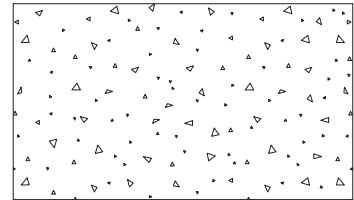

$$\Psi_b = \sqrt{\frac{f_{ck,cube}}{25}} \geq 1$$



MTH

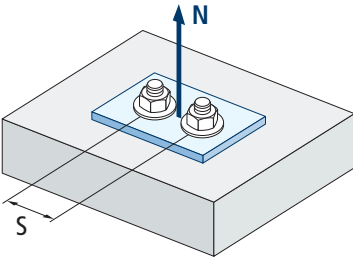

$$\psi_{s,N} = 0,5 + \frac{s}{2 \cdot s_{cr,N}} \leq 1$$

Influence of spacing (concrete cone) $\psi_{s,N}$							
s [mm]	MTH. Standard depth						
	M6	M8	M10	M12	M14	M16	M20
35	0,65						
40	0,67	0,64					
50	0,71	0,67	0,65				
55	0,73	0,69	0,67				Invalid value
60	0,75	0,71	0,68				
65	0,77	0,73	0,70				
70	0,79	0,74	0,71	0,68			
80	0,83	0,78	0,74	0,71			
85	0,85	0,80	0,76	0,72	0,69		
90	0,88	0,81	0,77	0,73	0,70		
100	0,92	0,85	0,80	0,76	0,72	0,70	
105	0,94	0,86	0,82	0,77	0,73	0,71	
110	0,96	0,88	0,83	0,78	0,74	0,72	
120	1,00	0,92	0,86	0,81	0,77	0,74	
125		0,93	0,88	0,82	0,78	0,75	
126		0,94	0,88	0,82	0,78	0,75	
128		0,94	0,89	0,83	0,78	0,75	
130		0,95	0,89	0,83	0,79	0,76	
135		0,97	0,91	0,85	0,80	0,77	0,72
144		1,00	0,94	0,87	0,82	0,79	0,73
150			0,95	0,88	0,83	0,80	0,74
165			1,00	0,92	0,87	0,83	0,77
170				0,94	0,88	0,84	0,78
180				0,96	0,90	0,86	0,79
195				1,00	0,93	0,89	0,82
200					0,94	0,90	0,82
210					0,97	0,92	0,84
220					0,99	0,94	0,86
225					1,00	0,95	0,86
252						1,00	0,91
255							0,91
260							0,92
300							0,99
309							1,00
s [mm]	MTH. Reduced depth						
	M6	M8	M10	M12	M14	M16	M20
40		0,69					
50		0,74	0,70				
55		0,76	0,72				
60		0,79	0,74				Invalid value
65		0,81	0,76				
70		0,83	0,78	0,73			
80		0,88	0,82	0,77			
85		0,90	0,84	0,78			
90		0,93	0,86	0,80			
100		0,98	0,90	0,83		0,73	
105		1,00	0,92	0,85		0,76	
110			0,94	0,87		0,77	
120			0,98	0,90		0,78	
125			1,00	0,92		0,81	
126			1,00	0,92		0,82	
128				0,93		0,82	
130				0,93		0,83	
135				0,95		0,83	
144				0,98		0,85	0,80
150				1,00		0,87	0,82
165						0,88	0,83
170						0,92	0,87
180						0,94	0,88
195						0,96	0,90
200						1,00	0,93
210							0,94
220							0,97
225							0,99
252							1,00
							Value without reduction = 1



MTH

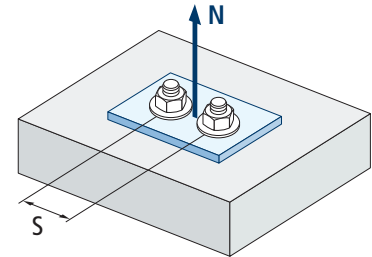

$$\Psi_{s,sp} = 0,5 + \frac{S}{2 \cdot S_{cr,sp}} \leq 1$$

Influence of spacing (concrete splitting) $\Psi_{s,sp}$							
s [mm]	MTH. Standard depth						
	M6	M8	M10	M12	M14	M16	M20
35	0,61						
40	0,63	0,60					
50	0,66	0,63	0,61				
55	0,67	0,64	0,63				
60	0,69	0,66	0,64				
65	0,70	0,67	0,65				
70	0,72	0,68	0,66	0,63			
80	0,75	0,71	0,68	0,65	0,63		
85	0,77	0,72	0,69	0,66	0,64		
90	0,78	0,73	0,70	0,67	0,65	0,66	
100	0,81	0,76	0,73	0,69	0,67	0,68	
110	0,84	0,79	0,75	0,71	0,68	0,70	
125	0,89	0,83	0,78	0,74	0,71	0,72	
128	0,90	0,83	0,79	0,75	0,71	0,73	
135	0,92	0,85	0,81	0,76	0,73	0,74	0,69
140	0,94	0,86	0,82	0,77	0,73	0,75	0,69
150	0,97	0,89	0,84	0,79	0,75	0,77	0,71
160	1,00	0,92	0,86	0,81	0,77	0,79	0,72
165		0,93	0,88	0,82	0,78	0,79	0,73
168		0,94	0,88	0,82	0,78	0,80	0,73
180		0,97	0,91	0,85	0,80	0,82	0,75
192		1,00	0,94	0,87	0,82	0,84	0,77
200			0,95	0,88	0,83	0,86	0,78
210			0,98	0,90	0,85	0,88	0,79
220			1,00	0,92	0,87	0,89	0,81
260				1,00	0,93	0,96	0,86
280					0,97	1,00	0,89
288					0,98		0,90
300					1,00		0,92
336							0,97
350							0,99
360							1,00
MTH. Reduced depth							
s [mm]	M6	M8	M10	M12	M14	M16	M20
40		0,64					
50		0,68	0,65				
55		0,70	0,66				
60		0,71	0,68				
65		0,73	0,69				
70		0,75	0,71	0,68			
80		0,79	0,74	0,70			
85		0,80	0,75	0,71			
90		0,82	0,77	0,73		0,67	
100		0,86	0,80	0,75		0,69	
110		0,89	0,83	0,78		0,71	
125		0,95	0,87	0,81		0,74	
128		0,96	0,88	0,82		0,75	
135		0,98	0,90	0,84		0,76	0,73
140		1,00	0,92	0,85		0,77	0,73
150			0,95	0,88		0,79	0,75
160			0,98	0,90		0,81	0,77
165			0,99	0,91		0,82	0,78
168			1,00	0,92		0,82	0,78
180				0,95		0,85	0,80
192				0,98		0,87	0,82
200				1,00		0,88	0,83
210						0,90	0,85
220						0,92	0,87
260						1,00	0,93
280							0,97
288							0,98
300							1,00

Value without reduction = 1

Value without reduction = 1



MTH

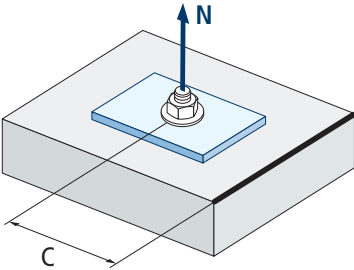

$$\psi_{c,sp} = 0,35 + \frac{0,5 \cdot c}{C_{cr,sp}} + \frac{0,15 \cdot c^2}{C_{cr,sp}^2} \leq 1$$

Influence of concrete edge distance (splitting) $\psi_{c,sp}$							
c [mm]	MTH. Standard depth						
	M6	M8	M10	M12	M14	M16	M20
35	0,60						
40	0,64	0,58					
50	0,72	0,65	0,61				
60	0,81	0,72	0,67				
65	0,86	0,76	0,70				
70	0,90	0,79	0,73	0,66			
75	0,95	0,83	0,76	0,69			
80	1,00	0,87	0,79	0,71	0,66		
83		0,89	0,81	0,73	0,67		
84		0,90	0,82	0,74	0,68		
85		0,91	0,83	0,74	0,68		
90		0,95	0,86	0,77	0,70	0,73	
96		1,00	0,90	0,80	0,73	0,76	
100			0,93	0,82	0,75	0,78	
105			0,96	0,85	0,77	0,81	
110			1,00	0,88	0,80	0,84	
125				0,97	0,87	0,92	
128				0,99	0,89	0,93	
130				1,00	0,90	0,94	
135					0,92	0,97	0,81
140					0,95	1,00	0,83
144					0,97		0,85
150					1,00		0,87
168							0,95
175							0,98
180							1,00

MTH. Reduced depth							
c [mm]	M6	M8	M10	M12	M14	M16	M20
	40		0,68				
50		0,78	0,70				
60		0,89	0,78				
65		0,94	0,83				
70		1,00	0,87	0,77			
75			0,92	0,81			
80			0,96	0,85			
83			0,99	0,87			
84			1,00	0,88			
85				0,88			
90				0,92		0,77	
96				0,97		0,80	
100				1,00		0,82	
105						0,85	
110						0,88	
125						0,97	
128						0,99	
130						1,00	
135							0,92
144							0,97
150							1,00



Influence of concrete edge distance (concrete cone) $\psi_{c,N}$							
c [mm]	MTH. Standard depth						
	M6	M8	M10	M12	M14	M16	M20
35	0,69						
40	0,75	0,67					
50	0,87	0,77	0,71				
53	0,91	0,80	0,73				
60	1,00	0,87	0,79				
63		0,90	0,82				
65		0,92	0,83				
70		0,98	0,88	0,78			
72		1,00	0,90	0,80			
75			0,92	0,82			
80			0,97	0,86	0,78		
83			1,00	0,88	0,80		
85				0,90	0,81		
90				0,94	0,84	0,78	
98				1,00	0,90	0,83	
100					0,91	0,84	
105					0,94	0,87	
110					0,98	0,90	
113					1,00	0,92	
125						0,99	
126						1,00	
128							
135							0,90
150							0,97
155							1,00

MTH. Reduced depth							
c [mm]	M6	M8	M10	M12	M14	M16	M20
	40		0,81				
50		0,96	0,84				
53		1,00	0,88				
60			0,96				
63			1,00				
65							
70				0,95			
72				0,97			
75				1,00			
80							
83							
85							
90						0,94	
98						1,00	
100							
105							
110							
113							
125							
126							
128							
135							1,00

MTH

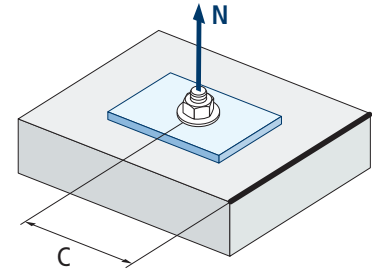

$$\psi_{c,N} = 0,35 + \frac{0,5 \cdot c}{C_{cr,N}} + \frac{0,15 \cdot c^2}{C_{cr,N}^2} \leq 1$$



MTH

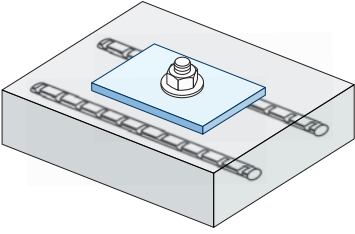

$$\Psi_{re,N} = 0,5 + \frac{h_{ef}}{200} \leq 1$$

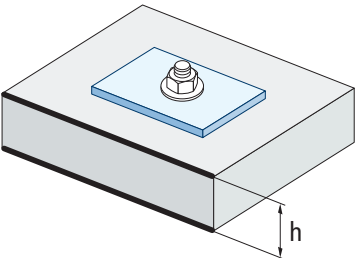

Influence of reinforcements $\Psi_{re,N}$							
$\Psi_{re,N}$	MTH. Standard depth						
	M6	M8	M10	M12	M14	M16	M20
	0,70	0,74	0,77	0,82	0,87	0,92	1,00
	MTH. Reduced depth						
	M6	M8	M10	M12	M14	M16	M20
	-	0,67	0,71	0,75	-	0,83	0,88

*This factor only applies for a high density of reinforcements. If in the area of the anchor there are reinforcements with a distancing of ≥ 150 mm (any diameter) or with a diameter ≤ 10 mm and a distancing of ≥ 100 mm, a $f_{re,N} = 1$ factor may be applied.

Influence of base material thickness $\Psi_{h,sp}$										
$\Psi_{h,sp}$	MTH									
	h/h _{ef}	2,00	2,20	2,40	2,60	2,80	3,00	3,20	3,40	3,60
$\Psi_{h,sp}$	1,00	1,07	1,13	1,19	1,25	1,31	1,37	1,42	1,48	1,50

$$\Psi_{h,sp} = \left(\frac{h}{2 \cdot h_{ef}} \right)^{2/3} \leq 1,5$$

SHEAR LOADS

- Steel design resistance without lever arm: $V_{Rd,s}$
- Pry-out design resistance: $V_{Rd,cp} = k \cdot N_{Rd,c}^o$
- Concrete edge design resistance: $V_{Rd,c} = V_{Rd,c}^o \cdot \Psi_b \cdot \Psi_{se,V} \cdot \Psi_{c,V} \cdot \Psi_{re,V} \cdot \Psi_{\alpha,V} \cdot \Psi_{h,V}$

Steel design resistance									
$V_{Rd,s}$									
Size			M6	M8	M10	M12	M14	M16	M20
$V_{Rd,s}$	Standard depth	[kN]	4,1	7,4	11,8	16,5	22,5	30,7	45,0
$V_{Rd,s}$	Reduced depth	[kN]	-	7,4	11,8	16,5	-	30,7	45,0

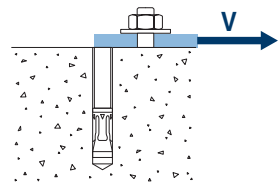

Pry-out design resistance*								
$V_{Rd,cp} = k \cdot N_{Rd,c}^o$								
Size		M6	M8	M10	M12	M14	M16	M20
k	(Standard depth)	1	1	1	2	2	2	2
k	(Reduced depth)	-	1	1	2	-	2	2

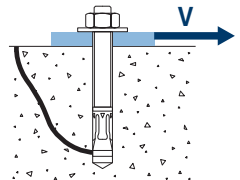

* $N_{Rd,c}^o$ Concrete cone design resistance for tension loads

Concrete edge resistance									
$V_{Rd,c} = V_{Rd,c}^o \cdot \Psi_b \cdot \Psi_{se,V} \cdot \Psi_{c,V} \cdot \Psi_{re,V} \cdot \Psi_{\alpha,V} \cdot \Psi_{h,V}$									
Size			M6	M8	M10	M12	M14	M16	M20
$V_{Rd,c}^o$	Standard depth	[kN]	4,6	6,2	7,7	10,2	12,9	15,6	21,8
$V_{Rd,c}^o$	Reduced depth	[kN]	-	3,6	4,9	6,5	-	10,1	12,8

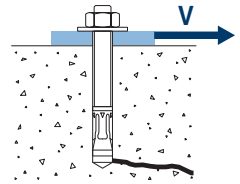



MTH

Coefficients of influence

Influence of concrete strength in concrete edge failure Ψ_b

		M6	M8	M10	M12	M14	M16	M20	
Ψ_b	C 20/25					1,00			
	C 30/37					1,22			
	C 40/50					1,41			
	C 50/60					1,55			

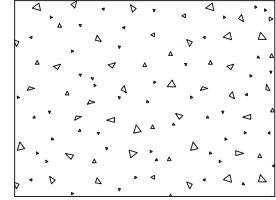

$$\Psi_b = \sqrt{\frac{f_{ck,cube}}{25}} \geq 1$$

Influence of edge distance and spacing $\Psi_{se,V}$

FOR ONE ANCHOR ONLY

c/h_{ef}	0,50	0,75	1,00	1,25	1,50	1,75	2,00	2,25	2,50	2,75	3,00	3,25	3,50	3,75	4,00	4,50	5,00
Isolated	0,35	0,65	1,00	1,40	1,84	2,32	2,83	3,38	3,95	4,56	5,20	5,86	6,55	7,26	8,00	9,55	11,18

FOR TWO ANCHORS

c/h_{ef}	0,50	0,75	1,00	1,25	1,50	1,75	2,00	2,25	2,50	2,75	3,00	3,25	3,50	3,75	4,00	4,50	5,00	
s/c	1,0	0,24	0,43	0,67	0,93	1,22	1,54	1,89	2,25	2,64	3,04	3,46	3,91	4,37	4,84	5,33	6,36	7,45
	1,5	0,27	0,49	0,75	1,05	1,38	1,74	2,12	2,53	2,96	3,42	3,90	4,39	4,91	5,45	6,00	7,16	8,39
	2,0	0,29	0,54	0,83	1,16	1,53	1,93	2,36	2,81	3,29	3,80	4,33	4,88	5,46	6,05	6,67	7,95	9,32
	2,5	0,32	0,60	0,92	1,28	1,68	2,12	2,59	3,09	3,62	4,18	4,76	5,37	6,00	6,66	7,33	8,75	10,25
	≥3,0	0,35	0,65	1,00	1,40	1,84	2,32	2,83	3,38	3,95	4,56	5,20	5,86	6,55	7,26	8,00	9,55	11,18

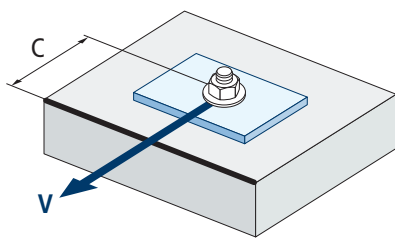

$$\Psi_{se,V} = \left(\frac{c}{h_{ef}}\right)^{1,5}$$

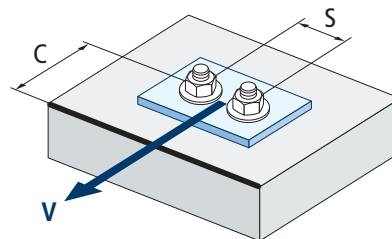

$$\Psi_{se,V} = \left(\frac{c}{h_{ef}}\right)^{1,5} \cdot \left(1 + \frac{s}{3 \cdot c}\right) \cdot 0,5 \leq \left(\frac{c}{h_{ef}}\right)^{1,5}$$



MTH

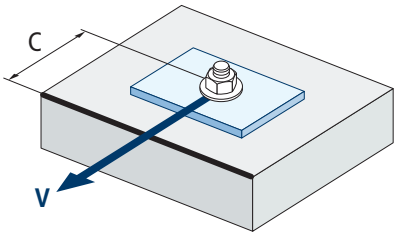

$$\psi_{c,v} = \left(\frac{d}{c} \right)^{0,20}$$

Influence of concrete edge distance $\psi_{c,v}$							
c [mm]	MTH						
	M6	M10	M10	M12	M14	M16	M20
35	0,70						
40	0,68	0,72					
45	0,67	0,71					
50	0,65	0,69	0,72				
55	0,64	0,68	0,71				
60	0,63	0,67	0,70				
70	0,61	0,65	0,68	0,70			
80	0,60	0,63	0,66	0,68	0,71		
85	0,59	0,62	0,65	0,68	0,70		
90	0,58	0,62	0,64	0,67	0,69	0,71	
100	0,57	0,60	0,63	0,65	0,67	0,69	
105	0,56	0,60	0,62	0,65	0,67	0,69	
110	0,56	0,59	0,62	0,64	0,66	0,68	
120	0,55	0,58	0,61	0,63	0,65	0,67	
125	0,54	0,58	0,60	0,63	0,65	0,66	
128	0,54	0,57	0,60	0,62	0,64	0,66	
130	0,54	0,57	0,60	0,62	0,64	0,66	
135	0,54	0,57	0,59	0,62	0,64	0,65	0,68
140	0,53	0,56	0,59	0,61	0,63	0,65	0,68
150	0,53	0,56	0,58	0,60	0,62	0,64	0,67
160	0,52	0,55	0,57	0,60	0,61	0,63	0,66
170	0,51	0,54	0,57	0,59	0,61	0,62	0,65
175	0,51	0,54	0,56	0,59	0,60	0,62	0,65
180	0,51	0,54	0,56	0,58	0,60	0,62	0,64
190	0,50	0,53	0,55	0,58	0,59	0,61	0,64
200	0,50	0,53	0,55	0,57	0,59	0,60	0,63
210	0,49	0,52	0,54	0,56	0,58	0,60	0,62
220	0,49	0,52	0,54	0,56	0,58	0,59	0,62
230	0,48	0,51	0,53	0,55	0,57	0,59	0,61
240	0,48	0,51	0,53	0,55	0,57	0,58	0,61
250	0,47	0,50	0,53	0,54	0,56	0,58	0,60
260	0,47	0,50	0,52	0,54	0,56	0,57	0,60
270	0,47	0,49	0,52	0,54	0,55	0,57	0,59
280	0,46	0,49	0,51	0,53	0,55	0,56	0,59
290	0,46	0,49	0,51	0,53	0,55	0,56	0,59
300	0,46	0,48	0,51	0,53	0,54	0,56	0,58



Influence of reinforcements $\Psi_{re,v}$			
	Without perimetral reinforcements	Perimetral reinforcements $\geq \text{Ø}12 \text{ mm}$	Perimetral reinforcements with brackets $\leq 100 \text{ mm}$
Non-cracked concrete	1	1	1

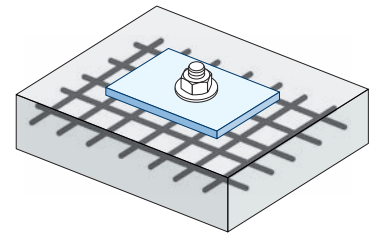

Influence of load application angle $\Psi_{\alpha,v}$										
Angle, $\alpha(^{\circ})$	0°	10°	20°	30°	40°	50°	60°	70°	80°	90°
$\Psi_{\alpha,v}$	1,00	1,01	1,05	1,13	1,24	1,40	1,64	1,97	2,32	2,50

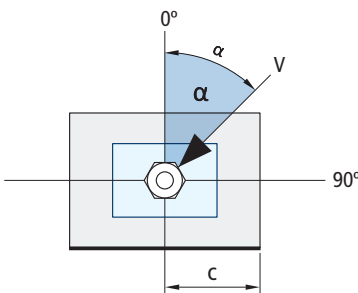

$$\Psi_{\alpha,v} = \sqrt{\frac{1}{(\cos \alpha_v)^2 + \left(\frac{\sin \alpha_v}{2,5}\right)^2}} \geq 1$$

Influence of base material thickness $\Psi_{h,v}$										
	MTH									
h/c	0,15	0,30	0,45	0,60	0,75	0,90	1,05	1,20	1,35	$\geq 1,5$
$\Psi_{h,v}$	0,32	0,45	0,55	0,63	0,71	0,77	0,84	0,89	0,95	1,00

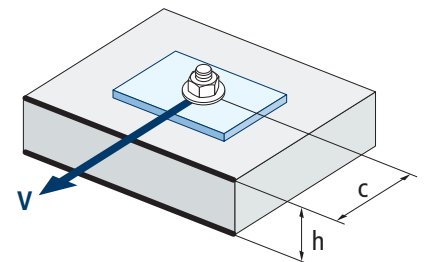

$$\Psi_{h,v} = \left(\frac{h}{1,5 \cdot c}\right)^{0,5} \geq 1,0$$



MTH

FIRE RESISTANCE

Characteristic Resistance*														
	TENSION							SHEAR						
	M6	M8	M10	M12	M14	M16	M20	M6	M8	M10	M12	M14	M16	M20
RF30	-	0,8	1,5	2,4	3,3	4,5	7,0	-	0,8	1,5	2,4	3,3	4,5	7,0
RF60	-	0,7	1,2	2,0	2,7	3,6	5,7	-	0,7	1,2	2,0	2,7	3,6	5,7
RF90	-	0,5	1,0	1,5	2,0	2,7	4,3	-	0,5	1,0	1,5	2,0	2,7	4,3
RF120	-	0,5	0,8	1,2	1,7	2,3	3,6	-	0,5	0,8	1,2	1,7	2,3	3,6

*The safety factor for design resistance under fire exposure is $\gamma_{M,fi}=1$ (in absence of other national regulations). As a result the Characteristic Resistance is the same as Design Resistance.

Maximum Load Recommended														
	TENSION							SHEAR						
	M6	M8	M10	M12	M14	M16	M20	M6	M8	M10	M12	M14	M16	M20
RF30	-	0,6	1,1	1,7	2,4	3,2	5,0	-	0,6	1,1	1,7	2,4	3,2	5,0
RF60	-	0,5	0,9	1,4	1,9	2,6	4,0	-	0,5	0,9	1,4	1,9	2,6	4,0
RF90	-	0,4	0,7	1,1	1,4	2,0	3,1	-	0,4	0,7	1,1	1,4	2,0	3,1
RF120	-	0,3	0,6	0,9	1,2	1,6	2,6	-	0,3	0,6	0,9	1,2	1,6	2,6

• Fire resistance values are not covered by ETA.

RANGE

Code	Size	Maximum thckn. of fixture	Axle letter (length)			Code	Size	Maximum thckn. of fixture	Axle letter (length)		
AH06060	M6 x 60 Ø6	2	B	200	1.200	AH10170	M10 x 170 Ø10	90	K	50	200
AH06070	M6 x 70 Ø6	12	C	200	1.200	AH10210	M10 x 210 Ø10	130	N	50	150
AH06080	M6 x 80 Ø6	22	D	200	1.200	AH10230	M10 x 230 Ø10	150	P	50	100
AH06090	M6 x 90 Ø6	32	E	200	1.200	AH12090	M12 x 90 Ø12	13	E	50	200
AH06100	M6 x 100 Ø6	42	E	200	800	AH12100	M12 x 100 Ø12	8	E	50	200
AH06110	M6 x 110 Ø6	52	F	200	800	AH12110	M12 x 110 Ø12	18	F	50	200
AH06120	M6 x 120 Ø6	62	G	100	600	AH12120	M12 x 120 Ø12	28	G	50	200
AH06130	M6 x 130 Ø6	72	H	100	600	AH12130	M12 x 130 Ø12	38	H	50	200
AH06140	M6 x 140 Ø6	82	I	100	400	AH12140	M12 x 140 Ø12	48	I	50	200
AH06150	M6 x 150 Ø6	92	I	100	400	AH12160	M12 x 160 Ø12	68	J	50	100
AH06160	M6 x 160 Ø6	102	J	100	400	AH12180	M12 x 180 Ø12	88	L	50	150
AH06170	M6 x 170 Ø6	112	K	100	400	AH12200	M12 x 200 Ø12	108	M	50	100
AH06180	M6 x 180 Ø6	122	L	100	300	AH12220	M12 x 220 Ø12	128	O	50	100
AH08060	M8 x 60 Ø8	3	B	100	600	AH12250	M12 x 250 Ø12	158	Q	25	50
AH08075	M8 x 75 Ø8	5	C	100	600	AH14120	M14 x 120 Ø14	12	G	25	100
AH08090	M8 x 90 Ø8	20	E	100	600	AH14145	M14 x 145 Ø14	37	I	25	100
AH08100	M8 x 100 Ø8	30	E	100	400	AH14170	M14 x 170 Ø14	62	K	25	100
AH08115	M8 x 115 Ø8	45	G	100	400	AH14220	M14 x 220 Ø14	112	O	25	75
AH08120	M8 x 120 Ø8	50	G	100	400	AH14250	M14 x 250 Ø14	142	Q	25	50
AH08130	M8 x 130 Ø8	60	H	100	400	AH16125	M16 x 125 Ø16	3	G	25	100
AH08155	M8 x 155 Ø8	85	J	100	200	AH16145	M16 x 145 Ø16	23	I	25	100
AH10070	M10 x 70 Ø10	3	C	100	400	AH16170	M16 x 170 Ø16	48	K	25	50
AH10080	M10 x 80 Ø10	13	D	100	400	AH16220	M16 x 220 Ø16	98	O	25	50
AH10090	M10 x 90 Ø10	10	E	100	400	AH16250	M16 x 250 Ø16	128	Q	25	50
AH10100	M10 x 100 Ø10	20	E	100	400	AH16280	M16 x 280 Ø16	158	S	25	50
AH10120	M10 x 120 Ø10	40	G	50	300	AH20170	M20 x 170 Ø20	23	K	20	40
AH10140	M10 x 140 Ø10	60	I	50	200	AH20220	M20 x 220 Ø20	73	O	20	40
AH10150	M10 x 150 Ø10	70	I	50	200	AH20270	M20 x 270 Ø20	123	S	20	40
AH10160	M10 x 160 Ø10	80	J	50	200						



Through-bolt expansion anchor with controlled torque, for use in non cracked concrete

MTH-A2

ETA Assessed Option 7. A2 Stainless shaft. A2 Stainless clip.

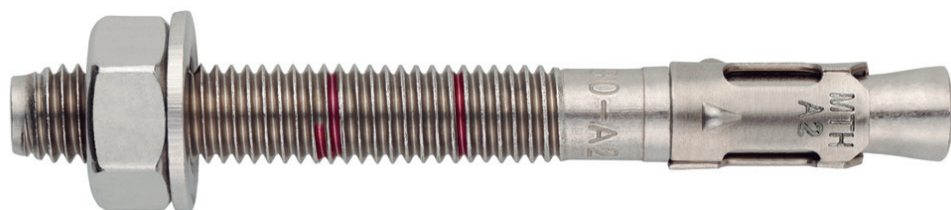

PRODUCT INFORMATION

DESCRIPTION

Metallic anchor, with male thread, expansion by controlled torque.

OFFICIAL DOCUMENTATION

- AVCP-1219-CPR-0006.
- ETA 05/0242 Option 7.
- Declaration of Performance DoP MTH-A2
- MFPA Fire Protection Assessment.

SIZES

M6x45 to M20x220.

DESIGN LOAD RANGE

From 6,0 to 27,8 kN [standard depth].
From 5,0 to 8,9 kN [reduced depth].



BASE MATERIAL

Concrete class from C20/25 to C50/60 non-cracked.



Stone

Concrete

Reinforced concrete

ASSESSMENTS

- Option 7 (non-cracked concrete).



05
Técnicas Expansivas S.L.
Segador 13. Logroño. Spain
ETA 05/0242
1219
Structural fixings in non
cracked concrete



CHARACTERISTICS AND BENEFITS

- Easy installation.
- Use in non-cracked concrete.
- Use for medium-heavy duty loads.
- Pre-installation or through the drill-hole of the fixture.
- Variety of lengths and diameters: flexibility in assembly.
- For static and quasi-static loads.
- Two installation depths in M8, M10 and M12 allowing the use in thick anchor plates or in low thickness base materials.
- Available at INDEXcal.
- Version in A2 Stainless steel (AISI 304).
- Available at INDEXcal.



MATERIALS

Shaft: A2 grade stainless steel.

Washer: A2 grade stainless steel.

Nut: A2 grade stainless steel.

Clip: A2 grade stainless steel.



APPLICATIONS

- Coastal areas.
- Industrial areas.
- Food industries.
- Curtain walls.
- Fixings in tunnels.
- Pipe supports.
- Rehabilitation of facades.
- For outdoor use in general.





MECHANICAL PROPERTIES

			M6	M8	M10	M12	M16	M20
Cone area section								
A_s	(mm ²)	Cone area section	14,5	27,3	49,0	70,9	122,7	201,1
$f_{u,s}$	(N/mm ²)	Characteristic tension resistance	700	700	700	700	700	700
$f_{y,s}$	(N/mm ²)	Yield strength	500	500	500	500	500	500
Threaded area section								
A_s	(mm ²)	Cone area section	20.1	36.6	58.0	84.3	157.0	245.0
$f_{u,s}$	(N/mm ²)	Characteristic tension resistance	600	600	600	600	600	600
$f_{y,s}$	(N/mm ²)	Yield Strength	400	400	400	400	400	400

INSTALLATION DATA

SIZE			M6	M8	M10	M12	M16	M20	
Code			MI06XXX	MI08XXX	MI10XXX	MI12XXX	MI16XXX	MI20XXX	
d_0	Nominal diameter of drill bit	[mm]	6	8	10	12	16	20	
T_{ins}	Installation torque moment	[Nm]	7	20	35	60	120	240	
$d_f \leq$	Diameter of clearance hole in the fixture	[mm]	7	9	12	14	18	22	
Standard depth	h_1	Minimum drill hole depth	[mm]	55	65	75	85	110	135
	h_{nom}	Installation depth	[mm]	49,5	59,5	66,5	77	103,5	125
	h_{ef}	Effective embedment depth	[mm]	40	48	55	65	84	103
	h_{min}	Minimum base material thickness	[mm]	100	100	110	130	168	206
	t_{fix}	Maximum thickness of fixture*	[mm]	L - 58	L - 70	L - 80	L - 92	L - 122	L - 147
	$s_{cr,N}$	Critical spacing	[mm]	120	144	165	195	252	309
	$c_{cr,N}$	Critical edge distance	[mm]	60	72	83	98	126	155
	$s_{cr,sp}$	Critical distance (splitting)	[mm]	160	192	220	260	336	412
	$c_{cr,sp}$	Critical edge distance (splitting)	[mm]	80	96	110	130	168	206
	Reduced depth	h_1	Minimum drill hole depth	[mm]	-	50	60	70	-
h_{nom}		Installation depth	[mm]	-	46,5	53,5	62	-	-
h_{ef}		Effective embedment depth	[mm]	-	35	42	50	-	-
h_{min}		Minimum base material thickness	[mm]	-	100	100	100	-	-
t_{fix}		Maximum thickness of fixture*	[mm]	-	L-57	L-67	L-77	-	-
$s_{cr,N}$		Critical spacing	[mm]	-	105	126	150	-	-
$c_{cr,N}$		Critical edge distance	[mm]	-	53	63	75	-	-
$s_{cr,sp}$		Critical distance (splitting)	[mm]	-	140	168	200	-	-
$c_{cr,sp}$		Critical edge distance (splitting)	[mm]	-	70	84	100	-	-
s_{min}		Minimum spacing	[mm]	50	65	70	85	110	135
c_{min}	Minimum edge distance	[mm]	50	65	70	85	110	135	
SW	Installation wrench		10	13	17	19	24	30	

*L = Total anchor length

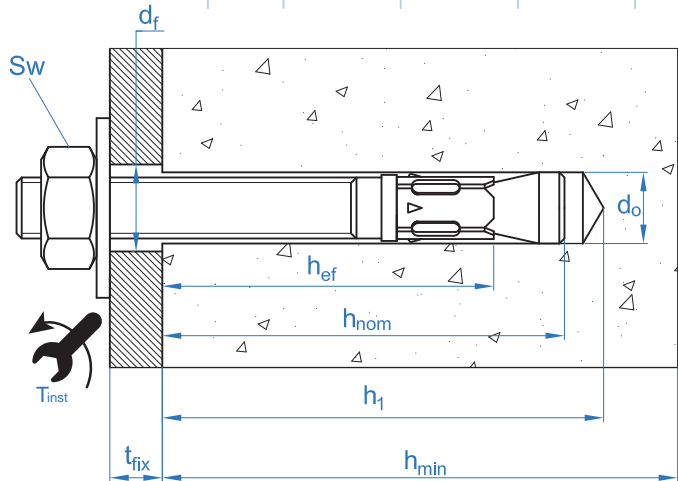



Code	INSTALLATION PRODUCTS
	Hammer drill
BHDSXXXXX	Concrete Drill bits
MOBOMBA	Blow pump
MORCEPKIT	Cleaning Brush
DOMTAXX	Installation hammering tool
	Torque wrench
	Hexagonal socket

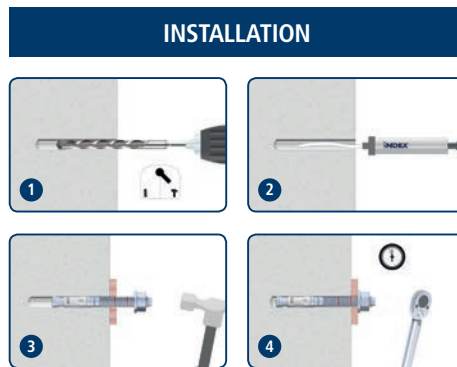

MTH-A2

Resistances in C20/25 concrete for an isolated anchor, without effects of edge distance or spacing

Characteristic Resistance N_{Rk} y V_{Rk}																	
TENSION								SHEAR									
Size		M6	M8	M10	M12	M16	M20	Size		M6	M8	M10	M12	M16	M20		
N_{Rk}	Standard depth	[kN]	10,1	12	16	25	35	50	V_{Rk}	Standard depth	[kN]	6,0	10,9	17,4	25,2	47,1	73,5
N_{Rk}	Reduced depth	[kN]	-	9	12	16	-	-	V_{Rk}	Reduced depth	[kN]	-	10,4	13,7	17,8	-	-

Design Resistance N_{Rd} y V_{Rd}																	
TENSION								SHEAR									
Size		M6	M8	M10	M12	M16	M20	Size		M6	M8	M10	M12	M16	M20		
N_{Rd}	Standard depth	[kN]	6,0	8,0	8,9	13,9	19,4	27,8	V_{Rd}	Standard depth	[kN]	3,9	7,1	11,4	16,6	30,1	48,3
N_{Rd}	Reduced depth	[kN]	-	5,0	6,7	8,9	-	-	V_{Rd}	Reduced depth	[kN]	-	7,0	9,1	11,9	-	-

Maximum Loads Recommended N_{rec} y V_{rec}																	
TENSION								SHEAR									
Size		M6	M8	M10	M12	M16	M20	Size		M6	M8	M10	M12	M16	M20		
N_{rec}	Standard depth	[kN]	4,3	5,7	6,3	9,9	13,9	19,8	V_{rec}	Standard depth	[kN]	2,8	5,1	8,2	11,8	22,1	34,5
N_{rec}	Reduced depth	[kN]	-	3,6	4,8	6,4	-	-	V_{rec}	Reduced depth	[kN]	-	4,9	6,5	8,5	-	-

Simplified calculation method

European Technical Assessment ETA 05/0242

Simplified version of the calculation method according to ETAG 001, annex C. Resistance is calculated according to the data shown in assessment ETA 05/0242.

- Influence of concrete strength.
- Influence of edge distance.
- Influence of spacing between anchors.
- Influence of reinforcements.
- Influence of base material thickness.
- Influence of load application angle.
- Valid for a group of two anchors.



INDEXcal

For a more accurate calculation and to take more constructive provisions into account, we recommend using our calculation program INDEXcal. It may be easily downloaded from our website www.indexfix.com

MTH-A2

TENSION LOADS

- Steel design resistance: $N_{Rd,s}$
- Pull-out design resistance: $N_{Rd,p} = N_{Rd,p}^o \cdot \psi_c$
- Concrete cone design resistance: $N_{Rd,c} = N_{Rd,c}^o \cdot \psi_b \cdot \psi_{s,N} \cdot \psi_{c,N} \cdot \psi_{re,N}$
- Concrete splitting design resistance: $N_{Rd,sp} = N_{Rd,c}^o \cdot \psi_b \cdot \psi_{s,sp} \cdot \psi_{c,sp} \cdot \psi_{re,N} \cdot \psi_{h,sp}$

Steel Design resistance								
$N_{Rd,s}$								
Size			M6	M8	M10	M12	M16	M20
N_{Rd}^o	Standard depth	[kN]	6,0	11,4	20,4	29,5	51,1	83,8

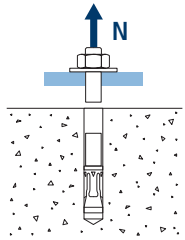

Pull-out design resistance								
$N_{Rd,p} = N_{Rd,p}^o \cdot \psi_c$								
Size			M6	M8	M10	M12	M16	M20
$N_{Rd,p}^o$	Standard depth	[kN]	-*	8,0	8,9	13,9	19,4	27,8
$N_{Rd,p}^o$	Reduced depth	[kN]	-	5,0	6,7	8,9	-	-

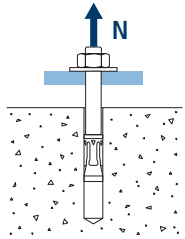

* Pull-out failure is not decisive.

Concrete cone design resistance								
$N_{Rd,c} = N_{Rd,c}^o \cdot \psi_b \cdot \psi_{s,N} \cdot \psi_{c,N} \cdot \psi_{re,N}$								
Concrete splitting design resistance*								
$N_{Rd,sp} = N_{Rd,c}^o \cdot \psi_b \cdot \psi_{s,sp} \cdot \psi_{c,sp} \cdot \psi_{re,N} \cdot \psi_{h,sp}$								
Size			M6	M8	M10	M12	M16	M20
$N_{Rd,c}^o$	Standard depth	[kN]	8,5	11,2	11,4	14,7	21,6	29,3
$N_{Rd,c}^o$	Reduced depth	[kN]	-	5,8	7,6	9,9	-	-

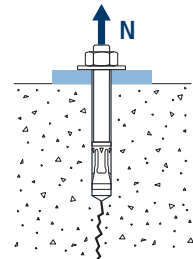
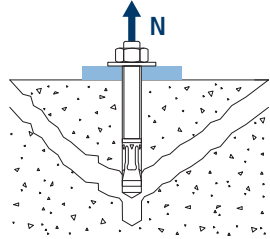

* Concrete splitting design resistance must only be considered for non-cracked concrete.



MTH-A2

Coefficients of influence

Influence of concrete strength resistance in pul-out failure ψ_c

		M6	M8	M10	M12	M16	M20	
ψ_c	C 20/25	1,00						
	C 30/37	1,22						
	C 40/50	1,41						
	C 50/60	1,55						

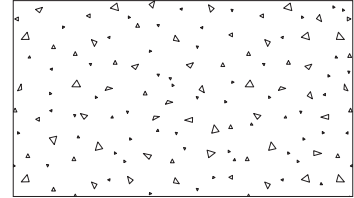
Influence of concrete strength in concrete cone and splitting failure ψ_b

		M6	M8	M10	M12	M16	M20	
ψ_b	C 20/25	1,00						
	C 30/37	1,22						
	C 40/50	1,41						
	C 50/60	1,55						

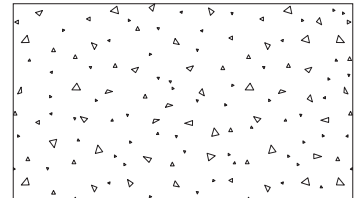

$$\psi_b = \sqrt{\frac{f_{ck,cube}}{25}} \geq 1$$



MTH-A2

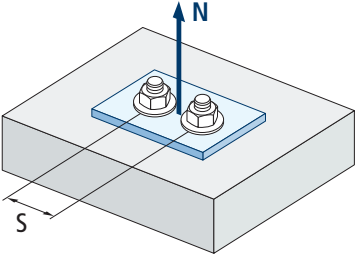

$$\psi_{s,N} = 0,5 + \frac{s}{2 \cdot s_{cr,N}} \leq 1$$

Influence of spacing (concrete cone) $\psi_{s,N}$						
s [mm]	MTH-A2. Standard depth					
	M6	M8	M10	M12	M16	M20
50	0,71					
55	0,73					
60	0,75					
65	0,77	0,73				
70	0,79	0,74	0,71			
80	0,83	0,78	0,74			
85	0,85	0,80	0,76	0,72		
90	0,88	0,81	0,77	0,73		
100	0,92	0,85	0,80	0,76		
105	0,94	0,86	0,82	0,77		
110	0,96	0,88	0,83	0,78	0,72	
120	1,00	0,92	0,86	0,81	0,74	
125		0,93	0,88	0,82	0,75	
126		0,94	0,88	0,82	0,75	
128		0,94	0,89	0,83	0,75	
130		0,95	0,89	0,83	0,76	
135		0,97	0,91	0,85	0,77	0,72
144		1,00	0,94	0,87	0,79	0,73
150			0,95	0,88	0,80	0,74
165			1,00	0,92	0,83	0,77
170				0,94	0,84	0,78
180				0,96	0,86	0,79
195				1,00	0,89	0,82
200					0,90	0,82
210					0,92	0,84
220					0,94	0,86
225					0,95	0,86
252					1,00	0,91
255						0,91
260						0,92
300						0,99
309						1,00

s [mm]	MTH-A2. Reduced depth					
	M6	M8	M10	M12	M16	M20
65		0,81				
70		0,83	0,78			
80		0,88	0,82			
85		0,90	0,84	0,78		
90		0,93	0,86	0,80		
100		0,98	0,90	0,83		
105		1,00	0,92	0,85		
110			0,94	0,87		
120			0,98	0,90		
125			1,00	0,92		
126			1,00	0,92		
128				0,93		
130				0,93		
135				0,95		
144				0,98		
150				1,00		



MTH-A2

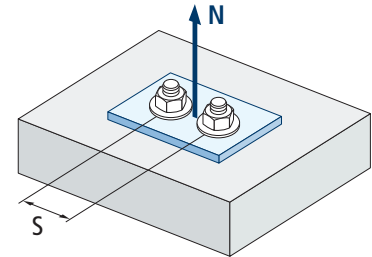

$$\Psi_{s,sp} = 0,5 + \frac{S}{2 \cdot S_{cr,sp}} \leq 1$$

Influence of spacing (concrete splitting) $\Psi_{s,sp}$						
s [mm]	MTH-A2. Standard depth					
	M6	M8	M10	M12	M16	M20
50	0,66					
55	0,67					
60	0,69					
65	0,70	0,67				
70	0,72	0,68	0,66			
80	0,75	0,71	0,68			
85	0,77	0,72	0,69	0,66		
90	0,78	0,73	0,70	0,67		
100	0,81	0,76	0,73	0,69		
110	0,84	0,79	0,75	0,71	0,66	
125	0,89	0,83	0,78	0,74	0,69	
128	0,90	0,83	0,79	0,75	0,69	
135	0,92	0,85	0,81	0,76	0,70	0,66
140	0,94	0,86	0,82	0,77	0,71	0,67
150	0,97	0,89	0,84	0,79	0,72	0,68
160	1,00	0,92	0,86	0,81	0,74	0,69
165		0,93	0,88	0,82	0,75	0,70
168		0,94	0,88	0,82	0,75	0,70
180		0,97	0,91	0,85	0,77	0,72
192		1,00	0,94	0,87	0,79	0,73
200			0,95	0,88	0,80	0,74
210			0,98	0,90	0,81	0,75
220			1,00	0,92	0,83	0,77
260				1,00	0,89	0,82
288					0,93	0,85
300					0,95	0,86
336					1,00	0,91
350						0,92
412						1,00

s [mm]	MTH-A2. Reduced depth					
	M6	M8	M10	M12	M16	M20
65		0,73				
70		0,75	0,71			
80		0,79	0,74			
85		0,80	0,75	0,71		
90		0,82	0,77	0,73		
100		0,86	0,80	0,75		
110		0,89	0,83	0,78		
125		0,95	0,87	0,81		
128		0,96	0,88	0,82		
135		0,98	0,90	0,84		
140		1,00	0,92	0,85		
150			0,95	0,88		
160			0,98	0,90		
165			0,99	0,91		
168			1,00	0,92		
180				0,95		
192				0,98		
200				1,00		



MTH-A2

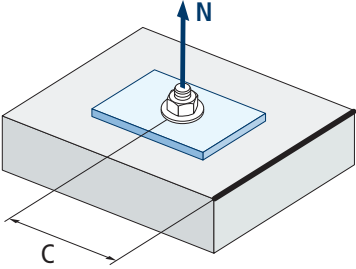

$$\Psi_{c,sp} = 0,35 + \frac{0,5 \cdot c}{C_{cr,sp}} + \frac{0,15 \cdot c^2}{C_{cr,sp}^2} \leq 1$$

Influence of concrete edge distance (splitting) $\Psi_{c,sp}$						
c [mm]	MTH-A2. Standard depth					
	M6	M8	M10	M12	M16	M20
50	0,72					
60	0,81					
65	0,86	0,76				Invalid value
70	0,90	0,79	0,73			
75	0,95	0,83	0,76			
80	1,00	0,87	0,79			
83		0,89	0,81			
84		0,90	0,82			
85		0,91	0,83	0,74		
90		0,95	0,86	0,77		
96		1,00	0,90	0,80		
100			0,93	0,82		
105			0,96	0,85		
110			1,00	0,88	0,74	
125				0,97	0,81	
128				0,99	0,82	
130				1,00	0,83	
135					0,85	0,74
144					0,89	0,77
150					0,92	0,79
168					1,00	0,86
175						0,88
180						0,90
206						1,00

c [mm]	MTH-A2. Reduced depth					
	M6	M8	M10	M12	M16	M20
50		0,78				
60		0,89	0,78			
65		0,94	0,83			Invalid value
70		1,00	0,87			
75			0,92			
80			0,96			
83			0,99	0,87		
84			1,00	0,88		
85				0,88		
90				0,92		
96				0,97		
100				1,00		



Influence of concrete edge distance (concrete cone) $\psi_{c,N}$						
c [mm]	MTH-A2. Standard depth					
	M6	M8	M10	M12	M16	M20
50	0,87					
53	0,91					
60	1,00					
63						
65		0,92				
70		0,98	0,88			
72		1,00	0,90			
75			0,92			
80			0,97			
83			1,00			
85				0,90		
90				0,94		
98				1,00		
100						
105						
110					0,90	
113					0,92	
125					0,99	
126					1,00	
128						
135						0,90
150						0,97
155						1,00

MTH-A2. Reduced depth						
c [mm]	M6	M8	M10	M12	M16	M20
	65		1,00			
70			1,00			
72						
75						
80						
83						
85				1,00		

MTH-A2

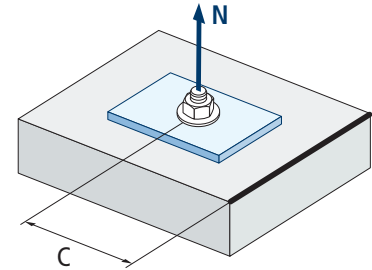

$$\psi_{c,N} = 0,35 + \frac{0,5 \cdot c}{C_{cr,N}} + \frac{0,15 \cdot c^2}{C_{cr,N}^2} \leq 1$$



MTH-A2

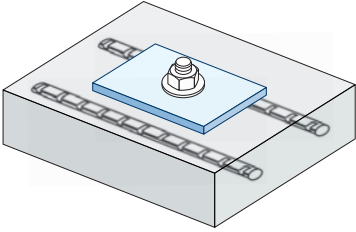

$$\Psi_{re,N} = 0,5 + \frac{h_{ef}}{200} \leq 1$$

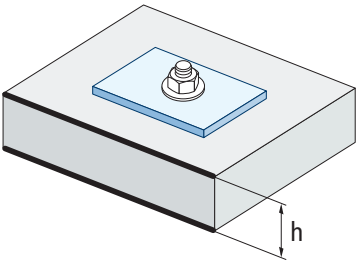

Influence of reinforcements $\Psi_{re,N}$						
$\Psi_{re,N}$	MTH-A2. Standard depth					
	M6	M8	M10	M12	M16	M20
	0,70	0,74	0,77	0,82	0,92	1,00
	MTH-A2. Reduced depth					
M6	M8	M10	M12	M16	M20	
-	0,67	0,71	0,75	-	-	

*This factor only applies for a high density of reinforcements. If in the area of the anchor there are reinforcements with a distancing of ≥ 150 mm (any diameter) or with a diameter ≤ 10 mm and a distancing of ≥ 100 mm, a $f_{re,N} = 1$ factor may be applied.

Influence of base material thickness $\Psi_{h,sp}$										
$\Psi_{h,sp}$	MTH-A2									
	h/h _{ef}	2,00	2,20	2,40	2,60	2,80	3,00	3,20	3,40	3,60
$\Psi_{h,sp}$	1,00	1,07	1,13	1,19	1,25	1,31	1,37	1,42	1,48	1,50

$$\Psi_{h,sp} = \left(\frac{h}{2 \cdot h_{ef}} \right)^{2/3} \leq 1,5$$

SHEAR LOADS

- Steel design resistance without lever arm: $V_{Rd,s}$
- Pry-out design resistance: $V_{Rd,cp} = k \cdot N_{Rd,c}^o$
- Concrete edge design resistance: $V_{Rd,c} = V_{Rd,c}^o \cdot \Psi_b \cdot \Psi_{se,V} \cdot \Psi_{c,V} \cdot \Psi_{re,V} \cdot \Psi_{\alpha,V} \cdot \Psi_{h,V}$

Steel design resistance								
$V_{Rd,s}$								
Size			M6	M8	M10	M12	M16	M20
$V_{Rd,s}$	Standard depth	[kN]	3,9	7,2	11,4	16,6	31,0	48,4
$V_{Rd,s}$	Reduced depth	[kN]	-	7,2	11,4	16,6	-	-

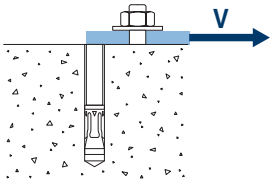

Pry-out design resistance*								
$V_{Rd,cp} = k \cdot N_{Rd,c}^o$								
Size			M6	M8	M10	M12	M16	M20
	k (Standard depth)		1	1	1	2	2	2
	k (Reduced depth)		-	1	1	1	-	-

* $N_{Rd,c}^o$ Concrete cone design resistance for tension loads

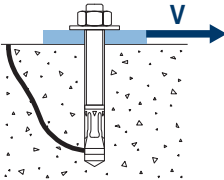

Concrete edge resistance								
$V_{Rd,c} = V_{Rd,c}^o \cdot \Psi_b \cdot \Psi_{se,V} \cdot \Psi_{c,V} \cdot \Psi_{re,V} \cdot \Psi_{\alpha,V} \cdot \Psi_{h,V}$								
Size			M6	M8	M10	M12	M16	M20
$V_{Rd,c}^o$	Standard depth	[kN]	4,6	6,2	7,7	10,2	15,6	21,8
$V_{Rd,c}^o$	Reduced depth	[kN]	-	3,7	4,9	6,6	-	-

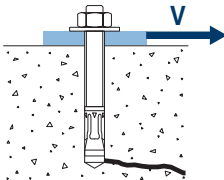



MTH-A2

Coefficients of influence

Influence of concrete strength in concrete edge failure Ψ_b

		M6	M8	M10	M12	M16	M20	
Ψ_b	C 20/25	1,00						
	C 30/37	1,22						
	C 40/50	1,41						
	C 50/60	1,55						

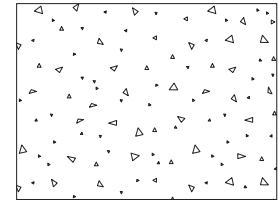

$$\Psi_b = \sqrt{\frac{f_{ck,cube}}{25}} \geq 1$$

Influence of edge distance and spacing $\Psi_{se,V}$

FOR ONE ANCHOR ONLY

c/h_{ef}	0,50	0,75	1,00	1,25	1,50	1,75	2,00	2,25	2,50	2,75	3,00	3,25	3,50	3,75	4,00	4,50	5,00
Isolated	0,35	0,65	1,00	1,40	1,84	2,32	2,83	3,38	3,95	4,56	5,20	5,86	6,55	7,26	8,00	9,55	11,18

FOR TWO ANCHORS

c/h_{ef}	0,50	0,75	1,00	1,25	1,50	1,75	2,00	2,25	2,50	2,75	3,00	3,25	3,50	3,75	4,00	4,50	5,00	
s/c	1,0	0,24	0,43	0,67	0,93	1,22	1,54	1,89	2,25	2,64	3,04	3,46	3,91	4,37	4,84	5,33	6,36	7,45
	1,5	0,27	0,49	0,75	1,05	1,38	1,74	2,12	2,53	2,96	3,42	3,90	4,39	4,91	5,45	6,00	7,16	8,39
	2,0	0,29	0,54	0,83	1,16	1,53	1,93	2,36	2,81	3,29	3,80	4,33	4,88	5,46	6,05	6,67	7,95	9,32
	2,5	0,32	0,60	0,92	1,28	1,68	2,12	2,59	3,09	3,62	4,18	4,76	5,37	6,00	6,66	7,33	8,75	10,25
	≥3,0	0,35	0,65	1,00	1,40	1,84	2,32	2,83	3,38	3,95	4,56	5,20	5,86	6,55	7,26	8,00	9,55	11,18

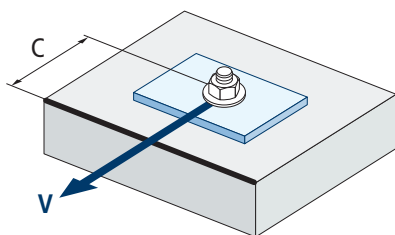

$$\Psi_{se,V} = \left(\frac{c}{h_{ef}}\right)^{1,5}$$

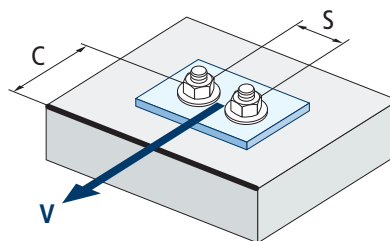

$$\Psi_{se,V} = \left(\frac{c}{h_{ef}}\right)^{1,5} \cdot \left(1 + \frac{s}{3 \cdot c}\right) \cdot 0,5 \leq \left(\frac{c}{h_{ef}}\right)^{1,5}$$



MTH-A2

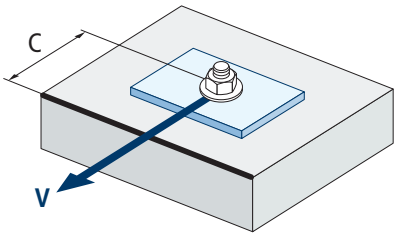

$$\psi_{c,v} = \left(\frac{d}{c} \right)^{0,20}$$

Influence of concrete edge distance $\psi_{c,v}$						
c [mm]	MTH-A2					
	M6	M10	M10	M12	M16	M20
40						
45						
50	0,65					
55	0,64					
60	0,63					
65	0,62	0,66				
70	0,61	0,65	0,68			
80	0,60	0,63	0,66			
85	0,59	0,62	0,65	0,68		
90	0,58	0,62	0,64	0,67		
100	0,57	0,60	0,63	0,65	0,67	
105	0,56	0,60	0,62	0,65	0,67	
110	0,56	0,59	0,62	0,64	0,66	0,68
120	0,55	0,58	0,61	0,63	0,65	0,67
125	0,54	0,58	0,60	0,63	0,65	0,66
130	0,54	0,57	0,60	0,62	0,64	0,66
135	0,54	0,57	0,59	0,62	0,64	0,65
140	0,53	0,56	0,59	0,61	0,63	0,65
150	0,53	0,56	0,58	0,60	0,62	0,64
160	0,52	0,55	0,57	0,60	0,61	0,63
170	0,51	0,54	0,57	0,59	0,61	0,62
175	0,51	0,54	0,56	0,59	0,60	0,62
180	0,51	0,54	0,56	0,58	0,60	0,62
190	0,50	0,53	0,55	0,58	0,59	0,61
200	0,50	0,53	0,55	0,57	0,59	0,60
210	0,49	0,52	0,54	0,56	0,58	0,60
220	0,49	0,52	0,54	0,56	0,58	0,59
230	0,48	0,51	0,53	0,55	0,57	0,59
240	0,48	0,51	0,53	0,55	0,57	0,58
250	0,47	0,50	0,53	0,54	0,56	0,58
260	0,47	0,50	0,52	0,54	0,56	0,57
270	0,47	0,49	0,52	0,54	0,55	0,57
280	0,46	0,49	0,51	0,53	0,55	0,56
290	0,46	0,49	0,51	0,53	0,55	0,56
300	0,46	0,48	0,51	0,53	0,54	0,56



Influence of reinforcements $\Psi_{re,v}$			
	Without perimetral reinforcements	Perimetral reinforcements $\geq \text{Ø}12 \text{ mm}$	Perimetral reinforcements with brackets $\leq 100 \text{ mm}$
Non-cracked concrete	1	1	1

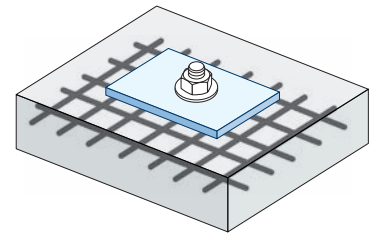

Influence of load application angle $\Psi_{\alpha,v}$										
Angle, $\alpha(^{\circ})$	0°	10°	20°	30°	40°	50°	60°	70°	80°	90°
$\Psi_{\alpha,v}$	1,00	1,01	1,05	1,13	1,24	1,40	1,64	1,97	2,32	2,50

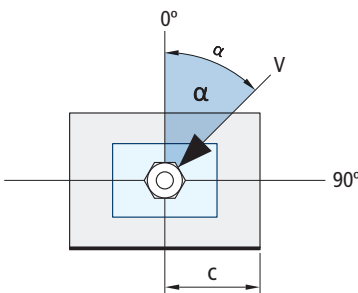

$$\Psi_{\alpha,v} = \sqrt{\frac{1}{(\cos \alpha_v)^2 + \left(\frac{\sin \alpha_v}{2,5}\right)^2}} \geq 1$$

Influence of base material thickness $\Psi_{h,v}$										
MTH-A2										
h/c	0,15	0,30	0,45	0,60	0,75	0,90	1,05	1,20	1,35	$\geq 1,5$
$\Psi_{h,v}$	0,32	0,45	0,55	0,63	0,71	0,77	0,84	0,89	0,95	1,00

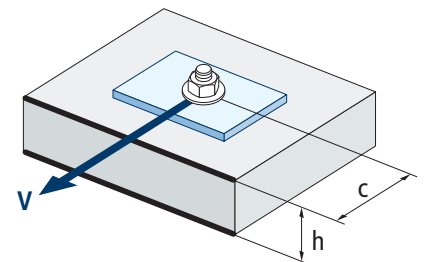

$$\Psi_{h,v} = \left(\frac{h}{1,5 \cdot c}\right)^{0,5} \geq 1,0$$



MTH-A2

FIRE RESISTANCE

Characteristic Resistance*												
	TENSION						SHEAR					
	M6	M8	M10	M12	M16	M20	M6	M8	M10	M12	M16	M20
RF30	-	0,8	1,5	2,4	4,5	7,0	-	0,8	1,5	2,4	4,5	7,0
RF60	-	0,7	1,2	2,0	3,6	5,7	-	0,7	1,2	2,0	3,6	5,7
RF90	-	0,5	1,0	1,5	2,7	4,3	-	0,5	1,0	1,5	2,7	4,3
RF120	-	0,5	0,8	1,2	2,3	3,6	-	0,5	0,8	1,2	2,3	3,6

*The safety factor for design resistance under fire exposure is $\gamma_{M,fi}=1$ (in absence of other national regulations). As a result the Characteristic Resistance is the same as Design Resistance.

Maximum Load Recommended												
	TENSION						SHEAR					
	M6	M8	M10	M12	M16	M20	M6	M8	M10	M12	M16	M20
RF30	-	0,6	1,1	1,7	3,2	5,0	-	0,6	1,1	1,7	3,2	5,0
RF60	-	0,5	0,9	1,4	2,6	4,0	-	0,5	0,9	1,4	2,6	4,0
RF90	-	0,4	0,7	1,1	2,0	3,1	-	0,4	0,7	1,1	2,0	3,1
RF120	-	0,3	0,6	0,9	1,6	2,6	-	0,3	0,6	0,9	1,6	2,6

• Fire resistance values are not covered by ETA.

RANGE

Code	Size	Maximum thickness of fixture	Axle letter (length)			Code	Size	Maximum thickness of fixture	Axle letter (length)		
• MI06045	M6 x 45 Ø6	1	A	200	1.200	MI10090	M10 x 90 Ø10	10	E	100	400
• MI06060	M6 x 60 Ø6	2	B	200	1.200	MI10120	M10 x 120 Ø10	40	G	50	300
• MI06080	M6 x 80 Ø6	22	D	200	1.200	MI10150	M10 x 150 Ø10	70	I	50	200
• MI06120	M6 x 120 Ø6	62	G	100	600	• MI12075	M12 x 75 Ø12	5	C	50	300
• MI06140	M6 x 140 Ø6	82	I	100	600	MI12090	M12 x 90 Ø12	13	E	50	200
• MI06160	M6 x 160 Ø6	102	J	100	400	MI12110	M12 x 110 Ø12	18	F	50	200
• MI06170	M6 x 170 Ø6	112	K	100	800	MI12140	M12 x 140 Ø12	48	I	50	200
• MI06180	M6 x 180 Ø6	122	L	100	600	• MI16090	M16 x 90 Ø16	4	E	25	150
• MI08050	M8 x 50 Ø8	4	A	100	800	MI16145	M16 x 145 Ø16	23	I	25	100
MI08075	M8 x 75 Ø8	5	C	100	600	MI16170	M16 x 170 Ø16	48	K	25	75
MI08090	M8 x 90 Ø8	20	E	100	600	• MI20120	M20 x 120 Ø20	5	G	20	40
MI08115	M8 x 115 Ø8	45	G	100	400	MI20170	M20 x 170 Ø20	23	K	20	40
MI10070	M10 x 70 Ø10	3	C	100	400	MI20220	M20 x 220 Ø20	73	O	20	40

• Non assessed sizes. Resistance values and installation data are not applicable to these references. For further information, please contact Technical Department.
• Non-assessed sizes for Fire Resistance.



Through-bolt expansion anchor with controlled torque, for use in non cracked concrete

MTH-A4

ETA Assessed Option 7. A4 Stainless shaft. A4 Stainless clip.

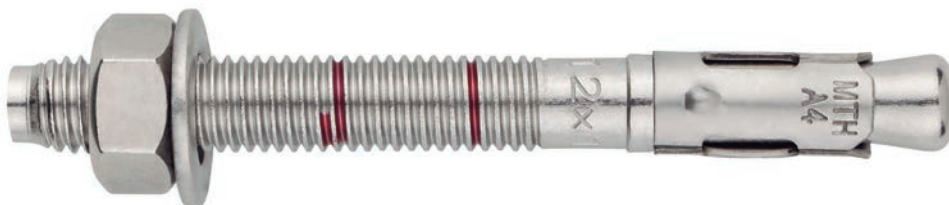

PRODUCT INFORMATION

DESCRIPTION

Metallic anchor, with male thread, expansion by controlled torque.

OFFICIAL DOCUMENTATION

- AVCP-1219-CPR-0006.
- ETA 05/0242 Option 7.
- Declaration of Performance DoP MTH-A4
- MFPA Fire Protection Assessment.

SIZES

M6x45 to M20x220.

DESIGN LOAD RANGE

From 6,0 to 27,8 kN [standard depth].
From 5,0 to 8,9 kN [reduced depth].



BASE MATERIAL

Concrete class from C20/25 to C50/60 non-cracked.



Stone

Concrete

Reinforced concrete

ASSESSMENTS

- Option 7 (non-cracked concrete).



05
Técnicas Expansivas S.L.
Segador 13. Logroño. Spain
ETA 05/0242
1219
Structural fixings in non
cracked concrete



CHARACTERISTICS AND BENEFITS

- Easy installation.
- Use in non-cracked concrete.
- Use for medium-heavy duty loads.
- Pre-installation or through the drill-hole of the fixture.
- Variety of lengths and diameters: flexibility in assembly.
- For static and quasi-static loads.
- Two installation depths in M8, M10 and M12 allowing the use in thick anchor plates or in low thickness base materials.
- Available at INDEXcal.
- Version in A4 Stainless steel [AISI 316].
- Available at INDEXcal.



MATERIALS

Shaft: A4 grade stainless steel.

Washer: A4 grade stainless steel.

Nut: A4 grade stainless steel.

Clip: A4 grade stainless steel.



APPLICATIONS

- Coastal areas.
- Industrial areas.
- Food industries.
- Curtain walls.
- Fixings in tunnels.
- Pipe supports.
- Rehabilitation of facades.
- For outdoor use in general.





MECHANICAL PROPERTIES

			M6	M8	M10	M12	M16	M20
Cone area section								
A_s	(mm ²)	Cone area section	14,5	27,3	49,0	70,9	122,7	201,1
$f_{u,s}$	(N/mm ²)	Characteristic tension resistance	700	700	700	700	700	700
$f_{y,s}$	(N/mm ²)	Yield strength	500	500	500	500	500	500
Threaded area section								
A_s	(mm ²)	Cone area section	20.1	36.6	58.0	84.3	157.0	245.0
$f_{u,s}$	(N/mm ²)	Characteristic tension resistance	600	600	600	600	600	600
$f_{y,s}$	(N/mm ²)	Yield Strength	400	400	400	400	400	400

INSTALLATION DATA

SIZE			M6	M8	M10	M12	M16	M20	
Code			MIA406XXX	MIA408XXX	MIA410XXX	MIA412XXX	MIA416XXX	MIA420XXX	
d_0	Nominal diameter of drill bit	[mm]	6	8	10	12	16	20	
T_{ins}	Installation torque moment	[Nm]	7	20	35	60	120	240	
$d_{f \leq}$	Diameter of clearance hole in the fixture	[mm]	7	9	12	14	18	22	
Standard depth	h_1	Minimum drill hole depth	[mm]	55	65	75	85	110	135
	h_{nom}	Installation depth	[mm]	49,5	59,5	66,5	77	103,5	125
	h_{ef}	Effective embedment depth	[mm]	40	48	55	65	84	103
	h_{min}	Minimum base material thickness	[mm]	100	100	110	130	168	206
	t_{fix}	Maximum thickness of fixture*	[mm]	L - 58	L - 70	L - 80	L - 92	L - 122	L - 147
	$s_{cr,N}$	Critical spacing	[mm]	120	144	165	195	252	309
	$c_{cr,N}$	Critical edge distance	[mm]	60	72	83	98	126	155
	$s_{cr,sp}$	Critical distance (splitting)	[mm]	160	192	220	260	336	412
	$c_{cr,sp}$	Critical edge distance (splitting)	[mm]	80	96	110	130	168	206
	Reduced depth	h_1	Minimum drill hole depth	[mm]	-	50	60	70	-
h_{nom}		Installation depth	[mm]	-	46,5	53,5	62	-	-
h_{ef}		Effective embedment depth	[mm]	-	35	42	50	-	-
h_{min}		Minimum base material thickness	[mm]	-	100	100	100	-	-
t_{fix}		Maximum thickness of fixture*	[mm]	-	L-57	L-67	L-77	-	-
$s_{cr,N}$		Critical spacing	[mm]	-	105	126	150	-	-
$c_{cr,N}$		Critical edge distance	[mm]	-	53	63	75	-	-
$s_{cr,sp}$		Critical distance (splitting)	[mm]	-	140	168	200	-	-
$c_{cr,sp}$		Critical edge distance (splitting)	[mm]	-	70	84	100	-	-
s_{min}		Minimum spacing	[mm]	50	65	70	85	110	135
c_{min}	Minimum edge distance	[mm]	50	65	70	85	110	135	
SW	Installation wrench		10	13	17	19	24	30	

*L = Total anchor length

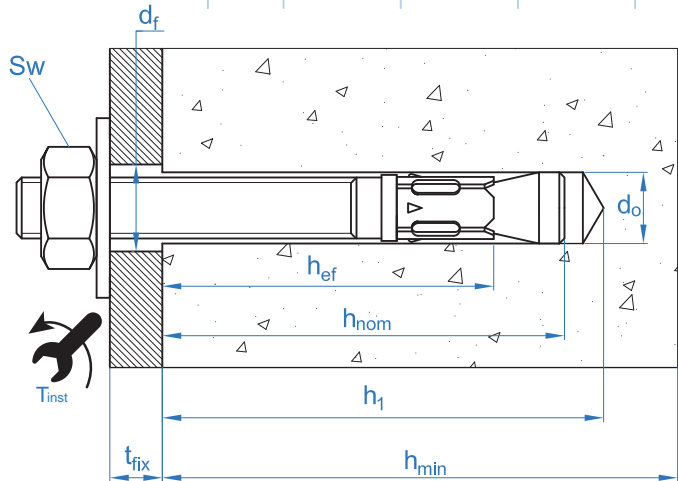



Code	INSTALLATION PRODUCTS
	Hammer drill
BHDSXXXXX	Concrete Drill bits
MOBOMBA	Blow pump
MORCEPKIT	Cleaning Brush
DOMTAXX	Installation hammering tool
	Torque wrench
	Hexagonal socket

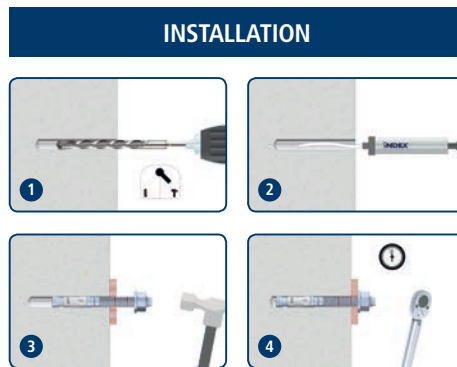

MTH-A4

Resistances in C20/25 concrete for an isolated anchor, without effects of edge distance or spacing

Characteristic Resistance N_{Rk} y V_{Rk}																	
TENSION								SHEAR									
Size		M6	M8	M10	M12	M16	M20	Size		M6	M8	M10	M12	M16	M20		
N_{Rk}	Standard depth	[kN]	10,1	12	16	25	35	50	V_{Rk}	Standard depth	[kN]	6,0	10,9	17,4	25,2	47,1	73,5
N_{Rk}	Reduced depth	[kN]	-	9	12	16	-	-	V_{Rk}	Reduced depth	[kN]	-	10,4	13,7	17,8	-	-

Design Resistance N_{Rd} y V_{Rd}																	
TENSION								SHEAR									
Size		M6	M8	M10	M12	M16	M20	Size		M6	M8	M10	M12	M16	M20		
N_{Rd}	Standard depth	[kN]	6,0	8,0	8,9	13,9	19,4	27,8	V_{Rd}	Standard depth	[kN]	3,9	7,1	11,4	16,6	30,1	48,3
N_{Rd}	Reduced depth	[kN]	-	5,0	6,7	8,9	-	-	V_{Rd}	Reduced depth	[kN]	-	7,0	9,1	11,9	-	-

Maximum Loads Recommended N_{rec} y V_{rec}																	
TENSION								SHEAR									
Size		M6	M8	M10	M12	M16	M20	Size		M6	M8	M10	M12	M16	M20		
N_{rec}	Standard depth	[kN]	4,3	5,7	6,3	9,9	13,9	19,8	V_{rec}	Standard depth	[kN]	2,8	5,1	8,2	11,8	22,1	34,5
N_{rec}	Reduced depth	[kN]	-	3,6	4,8	6,4	-	-	V_{rec}	Reduced depth	[kN]	-	4,9	6,5	8,5	-	-

Simplified calculation method

European Technical Assessment ETA 05/0242

Simplified version of the calculation method according to ETAG 001, annex C. Resistance is calculated according to the data shown in assessment ETA 05/0242.

- Influence of concrete strength.
- Influence of edge distance.
- Influence of spacing between anchors.
- Influence of reinforcements.
- Influence of base material thickness.
- Influence of load application angle.
- Valid for a group of two anchors.



INDEXcal

For a more accurate calculation and to take more constructive provisions into account, we recommend using our calculation program INDEXcal. It may be easily downloaded from our website www.indexfix.com



MTH-A4

TENSION LOADS

- Steel design resistance: $N_{Rd,s}$
- Pull-out design resistance: $N_{Rd,p} = N_{Rd,p}^o \cdot \psi_c$
- Concrete cone design resistance: $N_{Rd,c} = N_{Rd,c}^o \cdot \psi_b \cdot \psi_{s,N} \cdot \psi_{c,N} \cdot \psi_{re,N}$
- Concrete splitting design resistance: $N_{Rd,sp} = N_{Rd,c}^o \cdot \psi_b \cdot \psi_{s,sp} \cdot \psi_{c,sp} \cdot \psi_{re,N} \cdot \psi_{h,sp}$

Steel Design resistance								
$N_{Rd,s}$								
Size			M6	M8	M10	M12	M16	M20
N_{Rd}^o	Standard depth	[kN]	6,0	11,4	20,4	29,5	51,1	83,8

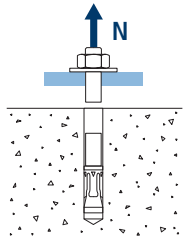

Pull-out design resistance								
$N_{Rd,p} = N_{Rd,p}^o \cdot \psi_c$								
Size			M6	M8	M10	M12	M16	M20
$N_{Rd,p}^o$	Standard depth	[kN]	-*	8,0	8,9	13,9	19,4	27,8
$N_{Rd,p}^o$	Reduced depth	[kN]	-	5,0	6,7	8,9	-	-

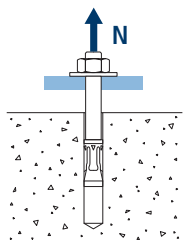

* Pull-out failure is not decisive.

Concrete cone design resistance								
$N_{Rd,c} = N_{Rd,c}^o \cdot \psi_b \cdot \psi_{s,N} \cdot \psi_{c,N} \cdot \psi_{re,N}$								
Concrete splitting design resistance*								
$N_{Rd,sp} = N_{Rd,c}^o \cdot \psi_b \cdot \psi_{s,sp} \cdot \psi_{c,sp} \cdot \psi_{re,N} \cdot \psi_{h,sp}$								
Size			M6	M8	M10	M12	M16	M20
$N_{Rd,c}^o$	Standard depth	[kN]	8,5	11,2	11,4	14,7	21,6	29,3
$N_{Rd,c}^o$	Reduced depth	[kN]	-	5,8	7,6	9,9	-	-

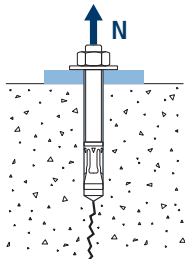
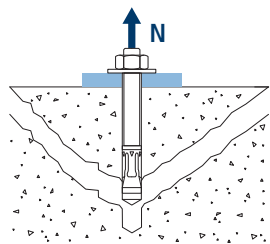

* Concrete splitting design resistance must only be considered for non-cracked concrete.



MTH-A4

Coefficients of influence

Influence of concrete strength resistance in pul-out failure ψ_c

		M6	M8	M10	M12	M16	M20	
ψ_c	C 20/25	1,00						
	C 30/37	1,22						
	C 40/50	1,41						
	C 50/60	1,55						

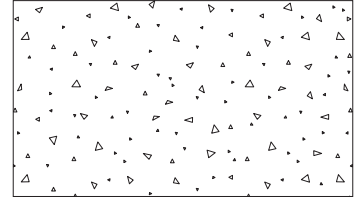
Influence of concrete strength in concrete cone and splitting failure ψ_b

		M6	M8	M10	M12	M16	M20	
ψ_b	C 20/25	1,00						
	C 30/37	1,22						
	C 40/50	1,41						
	C 50/60	1,55						

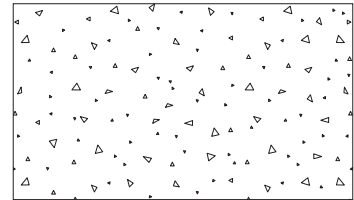

$$\psi_b = \sqrt{\frac{f_{ck,cube}}{25}} \geq 1$$



MTH-A4

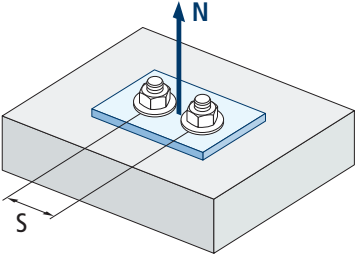

$$\psi_{s,N} = 0,5 + \frac{s}{2 \cdot s_{cr,N}} \leq 1$$

Influence of spacing (concrete cone) $\psi_{s,N}$						
s [mm]	MTH-A4. Standard depth					
	M6	M8	M10	M12	M16	M20
50	0,71					
55	0,73					
60	0,75					
65	0,77	0,73				
70	0,79	0,74	0,71			
80	0,83	0,78	0,74			
85	0,85	0,80	0,76	0,72		
90	0,88	0,81	0,77	0,73		
100	0,92	0,85	0,80	0,76		
105	0,94	0,86	0,82	0,77		
110	0,96	0,88	0,83	0,78	0,72	
120	1,00	0,92	0,86	0,81	0,74	
125		0,93	0,88	0,82	0,75	
126		0,94	0,88	0,82	0,75	
128		0,94	0,89	0,83	0,75	
130		0,95	0,89	0,83	0,76	
135		0,97	0,91	0,85	0,77	0,72
144		1,00	0,94	0,87	0,79	0,73
150			0,95	0,88	0,80	0,74
165			1,00	0,92	0,83	0,77
170				0,94	0,84	0,78
180				0,96	0,86	0,79
195				1,00	0,89	0,82
200					0,90	0,82
210					0,92	0,84
220					0,94	0,86
225					0,95	0,86
252					1,00	0,91
255						0,91
260						0,92
300						0,99
309						1,00

s [mm]	MTH-A4. Reduced depth					
	M6	M8	M10	M12	M16	M20
65		0,81				
70		0,83	0,78			
80		0,88	0,82			
85		0,90	0,84	0,78		
90		0,93	0,86	0,80		
100		0,98	0,90	0,83		
105		1,00	0,92	0,85		
110			0,94	0,87		
120			0,98	0,90		
125			1,00	0,92		
126			1,00	0,92		
128				0,93		
130				0,93		
135				0,95		
144				0,98		
150				1,00		



MTH-A4

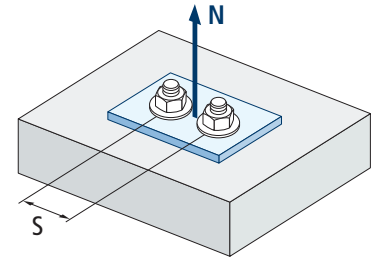

$$\Psi_{s,sp} = 0,5 + \frac{S}{2 \cdot S_{cr,sp}} \leq 1$$

Influence of spacing (concrete splitting) $\Psi_{s,sp}$						
s [mm]	MTH-A4. Standard depth					
	M6	M8	M10	M12	M16	M20
50	0,66					
55	0,67					
60	0,69					
65	0,70	0,67				
70	0,72	0,68	0,66			
80	0,75	0,71	0,68			
85	0,77	0,72	0,69	0,66		
90	0,78	0,73	0,70	0,67		
100	0,81	0,76	0,73	0,69		
110	0,84	0,79	0,75	0,71	0,66	
125	0,89	0,83	0,78	0,74	0,69	
128	0,90	0,83	0,79	0,75	0,69	
135	0,92	0,85	0,81	0,76	0,70	0,66
140	0,94	0,86	0,82	0,77	0,71	0,67
150	0,97	0,89	0,84	0,79	0,72	0,68
160	1,00	0,92	0,86	0,81	0,74	0,69
165		0,93	0,88	0,82	0,75	0,70
168		0,94	0,88	0,82	0,75	0,70
180		0,97	0,91	0,85	0,77	0,72
192		1,00	0,94	0,87	0,79	0,73
200			0,95	0,88	0,80	0,74
210			0,98	0,90	0,81	0,75
220			1,00	0,92	0,83	0,77
260				1,00	0,89	0,82
288					0,93	0,85
300					0,95	0,86
336					1,00	0,91
350						0,92
412						1,00

s [mm]	MTH-A4. Reduced depth					
	M6	M8	M10	M12	M16	M20
65		0,73				
70		0,75	0,71			
80		0,79	0,74			
85		0,80	0,75	0,71		
90		0,82	0,77	0,73		
100		0,86	0,80	0,75		
110		0,89	0,83	0,78		
125		0,95	0,87	0,81		
128		0,96	0,88	0,82		
135		0,98	0,90	0,84		
140		1,00	0,92	0,85		
150			0,95	0,88		
160			0,98	0,90		
165			0,99	0,91		
168			1,00	0,92		
180				0,95		
192				0,98		
200				1,00		



MTH-A4

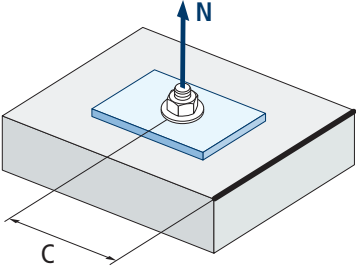

$$\psi_{c,sp} = 0,35 + \frac{0,5 \cdot c}{C_{cr,sp}} + \frac{0,15 \cdot c^2}{C_{cr,sp}^2} \leq 1$$

Influence of concrete edge distance (splitting) $\psi_{c,sp}$						
c [mm]	MTH-A4. Standard depth					
	M6	M8	M10	M12	M16	M20
50	0,72					
60	0,81					
65	0,86	0,76				Invalid value
70	0,90	0,79	0,73			
75	0,95	0,83	0,76			
80	1,00	0,87	0,79			
83		0,89	0,81			
84		0,90	0,82			
85		0,91	0,83	0,74		
90		0,95	0,86	0,77		
96		1,00	0,90	0,80		
100			0,93	0,82		
105			0,96	0,85		
110			1,00	0,88	0,74	
125				0,97	0,81	
128				0,99	0,82	
130				1,00	0,83	
135					0,85	0,74
144					0,89	0,77
150					0,92	0,79
168					1,00	0,86
175						0,88
180						0,90
206						1,00

c [mm]	MTH-A4. Reduced depth					
	M6	M8	M10	M12	M16	M20
50		0,78				
60		0,89	0,78			
65		0,94	0,83			Invalid value
70		1,00	0,87			
75			0,92			
80			0,96			
83			0,99	0,87		
84			1,00	0,88		
85				0,88		
90				0,92		
96				0,97		
100				1,00		

Influence of concrete edge distance (concrete cone) $\psi_{c,N}$

c [mm]	MTH-A4. Standard depth					
	M6	M8	M10	M12	M16	M20
50	0,87					
53	0,91					
60	1,00					
63						
65		0,92				
70		0,98	0,88			
72		1,00	0,90			
75			0,92			
80			0,97			
83			1,00			
85				0,90		
90				0,94		
98				1,00		
100						
105						
110					0,90	
113					0,92	
125					0,99	
126					1,00	
128						
135						0,90
150						0,97
155						1,00

Value without reduction = 1

Invalid value

MTH-A4

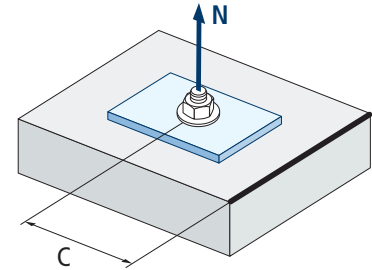

$$\psi_{c,N} = 0,35 + \frac{0,5 \cdot c}{C_{cr,N}} + \frac{0,15 \cdot c^2}{C_{cr,N}^2} \leq 1$$

c [mm]	MTH-A4. Reduced depth					
	M6	M8	M10	M12	M16	M20
65		1,00				
70			1,00			
72						
75						
80						
83						
85				1,00		

Value without reduction = 1

Invalid value



MTH-A4

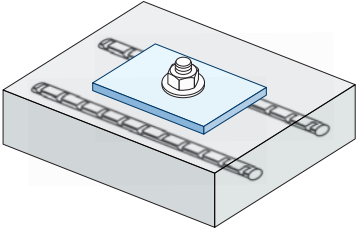

$$\Psi_{re,N} = 0,5 + \frac{h_{ef}}{200} \leq 1$$

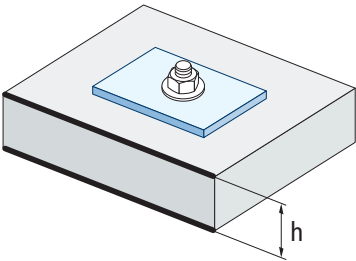

Influence of reinforcements $\Psi_{re,N}$						
$\Psi_{re,N}$	MTH-A4. Standard depth					
	M6	M8	M10	M12	M16	M20
	0,70	0,74	0,77	0,82	0,92	1,00
	MTH-A4. Reduced depth					
M6	M8	M10	M12	M16	M20	
-	0,67	0,71	0,75	-	-	

*This factor only applies for a high density of reinforcements. If in the area of the anchor there are reinforcements with a distancing of ≥ 150 mm (any diameter) or with a diameter ≤ 10 mm and a distancing of ≥ 100 mm, a $f_{re,N} = 1$ factor may be applied.

Influence of base material thickness $\Psi_{h,sp}$											
$\Psi_{h,sp}$	MTH-A4										
	h/h _{ef}	2,00	2,20	2,40	2,60	2,80	3,00	3,20	3,40	3,60	$\geq 3,68$
	$\Psi_{h,sp}$	1,00	1,07	1,13	1,19	1,25	1,31	1,37	1,42	1,48	1,50

$$\Psi_{h,sp} = \left(\frac{h}{2 \cdot h_{ef}} \right)^{2/3} \leq 1,5$$

SHEAR LOADS

- Steel design resistance without lever arm: $V_{Rd,s}$
- Pry-out design resistance: $V_{Rd,cp} = k \cdot N_{Rd,c}^o$
- Concrete edge design resistance: $V_{Rd,c} = V_{Rd,c}^o \cdot \Psi_b \cdot \Psi_{se,V} \cdot \Psi_{c,V} \cdot \Psi_{re,V} \cdot \Psi_{\alpha,V} \cdot \Psi_{h,V}$

Steel design resistance								
$V_{Rd,s}$								
Size			M6	M8	M10	M12	M16	M20
$V_{Rd,s}$	Standard depth	[kN]	3,9	7,2	11,4	16,6	31,0	48,4
$V_{Rd,s}$	Reduced depth	[kN]	-	7,2	11,4	16,6	-	-

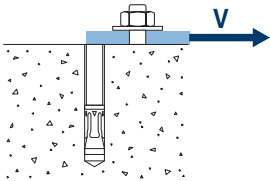

Pry-out design resistance*						
$V_{Rd,cp} = k \cdot N_{Rd,c}^o$						
Size	M6	M8	M10	M12	M16	M20
k (Standard depth)	1	1	1	2	2	2
k (Reduced depth)	-	1	1	1	-	-

* $N_{Rd,c}^o$ Concrete cone design resistance for tension loads

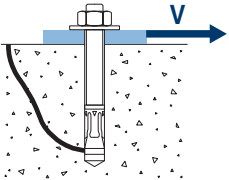

Concrete edge resistance								
$V_{Rd,c} = V_{Rd,c}^o \cdot \Psi_b \cdot \Psi_{se,V} \cdot \Psi_{c,V} \cdot \Psi_{re,V} \cdot \Psi_{\alpha,V} \cdot \Psi_{h,V}$								
Size			M6	M8	M10	M12	M16	M20
$V_{Rd,c}^o$	Standard depth	[kN]	4,6	6,2	7,7	10,2	15,6	21,8
$V_{Rd,c}^o$	Reduced depth	[kN]	-	3,7	4,9	6,6	-	-

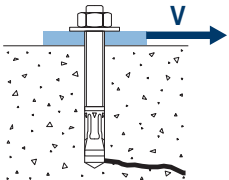



MTH-A4

Coefficients of influence

Influence of concrete strength in concrete edge failure Ψ_b								
		M6	M8	M10	M12	M16	M20	
Ψ_b	C 20/25	1,00						
	C 30/37	1,22						
	C 40/50	1,41						
	C 50/60	1,55						

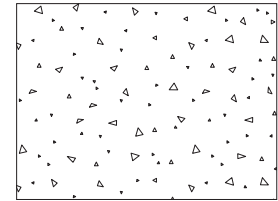

$$\Psi_b = \sqrt{\frac{f_{ck,cube}}{25}} \geq 1$$

Influence of edge distance and spacing $\Psi_{se,V}$																		
FOR ONE ANCHOR ONLY																		
c/h_{ef}	0,50	0,75	1,00	1,25	1,50	1,75	2,00	2,25	2,50	2,75	3,00	3,25	3,50	3,75	4,00	4,50	5,00	
Isolated	0,35	0,65	1,00	1,40	1,84	2,32	2,83	3,38	3,95	4,56	5,20	5,86	6,55	7,26	8,00	9,55	11,18	
FOR TWO ANCHORS																		
c/h_{ef}	0,50	0,75	1,00	1,25	1,50	1,75	2,00	2,25	2,50	2,75	3,00	3,25	3,50	3,75	4,00	4,50	5,00	
s/c	1,0	0,24	0,43	0,67	0,93	1,22	1,54	1,89	2,25	2,64	3,04	3,46	3,91	4,37	4,84	5,33	6,36	7,45
	1,5	0,27	0,49	0,75	1,05	1,38	1,74	2,12	2,53	2,96	3,42	3,90	4,39	4,91	5,45	6,00	7,16	8,39
	2,0	0,29	0,54	0,83	1,16	1,53	1,93	2,36	2,81	3,29	3,80	4,33	4,88	5,46	6,05	6,67	7,95	9,32
	2,5	0,32	0,60	0,92	1,28	1,68	2,12	2,59	3,09	3,62	4,18	4,76	5,37	6,00	6,66	7,33	8,75	10,25
	$\geq 3,0$	0,35	0,65	1,00	1,40	1,84	2,32	2,83	3,38	3,95	4,56	5,20	5,86	6,55	7,26	8,00	9,55	11,18

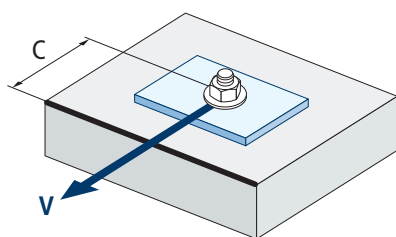

$$\Psi_{se,V} = \left(\frac{c}{h_{ef}}\right)^{1,5}$$

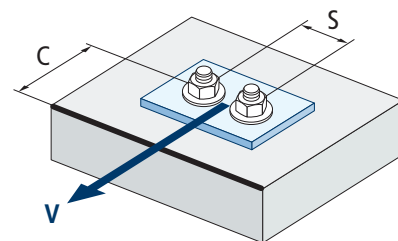

$$\Psi_{se,V} = \left(\frac{c}{h_{ef}}\right)^{1,5} \cdot \left(1 + \frac{s}{3 \cdot c}\right) \cdot 0,5 \leq \left(\frac{c}{h_{ef}}\right)^{1,5}$$



MTH-A4

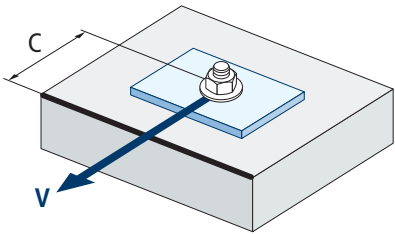

$$\psi_{c,v} = \left(\frac{d}{c} \right)^{0,20}$$

Influence of concrete edge distance $\psi_{c,v}$						
c [mm]	MTH-A4					
	M6	M10	M10	M12	M16	M20
40						
45						
50	0,65					
55	0,64					
60	0,63					
65	0,62	0,66				
70	0,61	0,65	0,68			
80	0,60	0,63	0,66			
85	0,59	0,62	0,65	0,68		
90	0,58	0,62	0,64	0,67		
100	0,57	0,60	0,63	0,65	0,67	
105	0,56	0,60	0,62	0,65	0,67	
110	0,56	0,59	0,62	0,64	0,66	0,68
120	0,55	0,58	0,61	0,63	0,65	0,67
125	0,54	0,58	0,60	0,63	0,65	0,66
130	0,54	0,57	0,60	0,62	0,64	0,66
135	0,54	0,57	0,59	0,62	0,64	0,65
140	0,53	0,56	0,59	0,61	0,63	0,65
150	0,53	0,56	0,58	0,60	0,62	0,64
160	0,52	0,55	0,57	0,60	0,61	0,63
170	0,51	0,54	0,57	0,59	0,61	0,62
175	0,51	0,54	0,56	0,59	0,60	0,62
180	0,51	0,54	0,56	0,58	0,60	0,62
190	0,50	0,53	0,55	0,58	0,59	0,61
200	0,50	0,53	0,55	0,57	0,59	0,60
210	0,49	0,52	0,54	0,56	0,58	0,60
220	0,49	0,52	0,54	0,56	0,58	0,59
230	0,48	0,51	0,53	0,55	0,57	0,59
240	0,48	0,51	0,53	0,55	0,57	0,58
250	0,47	0,50	0,53	0,54	0,56	0,58
260	0,47	0,50	0,52	0,54	0,56	0,57
270	0,47	0,49	0,52	0,54	0,55	0,57
280	0,46	0,49	0,51	0,53	0,55	0,56
290	0,46	0,49	0,51	0,53	0,55	0,56
300	0,46	0,48	0,51	0,53	0,54	0,56



Influence of reinforcements $\Psi_{re,v}$			
	Without perimetral reinforcements	Perimetral reinforcements $\geq \text{Ø}12 \text{ mm}$	Perimetral reinforcements with brackets $\leq 100 \text{ mm}$
Non-cracked concrete	1	1	1

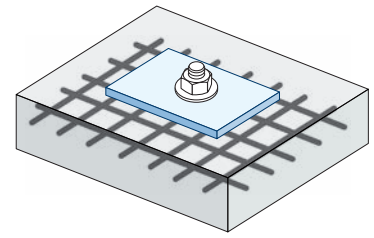

Influence of load application angle $\Psi_{\alpha,v}$										
Angle, $\alpha(^{\circ})$	0°	10°	20°	30°	40°	50°	60°	70°	80°	90°
$\Psi_{\alpha,v}$	1,00	1,01	1,05	1,13	1,24	1,40	1,64	1,97	2,32	2,50

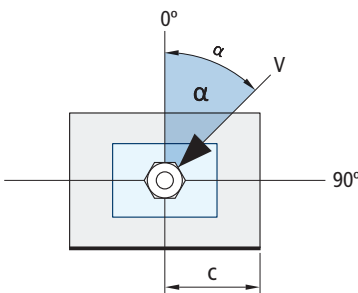

$$\Psi_{\alpha,v} = \sqrt{\frac{1}{(\cos \alpha_v)^2 + \left(\frac{\sin \alpha_v}{2,5}\right)^2}} \geq 1$$

Influence of base material thickness $\Psi_{h,v}$										
MTH-A4										
h/c	0,15	0,30	0,45	0,60	0,75	0,90	1,05	1,20	1,35	$\geq 1,5$
$\Psi_{h,v}$	0,32	0,45	0,55	0,63	0,71	0,77	0,84	0,89	0,95	1,00

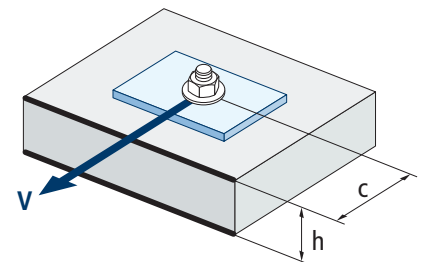

$$\Psi_{h,v} = \left(\frac{h}{1,5 \cdot c}\right)^{0,5} \geq 1,0$$



MTH-A4

FIRE RESISTANCE

Characteristic Resistance*												
	TENSION						SHEAR					
	M6	M8	M10	M12	M16	M20	M6	M8	M10	M12	M16	M20
RF30	-	0,8	1,5	2,4	4,5	7,0	-	0,8	1,5	2,4	4,5	7,0
RF60	-	0,7	1,2	2,0	3,6	5,7	-	0,7	1,2	2,0	3,6	5,7
RF90	-	0,5	1,0	1,5	2,7	4,3	-	0,5	1,0	1,5	2,7	4,3
RF120	-	0,5	0,8	1,2	2,3	3,6	-	0,5	0,8	1,2	2,3	3,6

*The safety factor for design resistance under fire exposure is $\gamma_{M,fi}=1$ (in absence of other national regulations). As a result the Characteristic Resistance is the same as Design Resistance.

Maximum Load Recommended												
	TENSION						SHEAR					
	M6	M8	M10	M12	M16	M20	M6	M8	M10	M12	M16	M20
RF30	-	0,6	1,1	1,7	3,2	5,0	-	0,6	1,1	1,7	3,2	5,0
RF60	-	0,5	0,9	1,4	2,6	4,0	-	0,5	0,9	1,4	2,6	4,0
RF90	-	0,4	0,7	1,1	2,0	3,1	-	0,4	0,7	1,1	2,0	3,1
RF120	-	0,3	0,6	0,9	1,6	2,6	-	0,3	0,6	0,9	1,6	2,6

• Fire resistance values are not covered by ETA.

RANGE

Code	Size	Maximum thickness of fixture	Axle letter (length)			Code	Size	Maximum thickness of fixture	Axle letter (length)		
• MIA406045	M6 x 45 Ø6	1	A	200	1.200	• MIA412075	M12 x 75 Ø12	5	C	50	300
MIA406060	M6 x 60 Ø6	2	B	200	1.200	MIA412090	M12 x 90 Ø12	13	E	50	200
MIA406080	M6 x 80 Ø6	22	D	200	1.200	MIA412110	M12 x 110 Ø12	12	F	50	200
• MIA408050	M8 x 50 Ø8	4	A	100	800	MIA412140	M12 x 140 Ø12	42	I	50	200
MIA408075	M8 x 75 Ø8	5	C	100	600	• MIA416090	M16 x 90 Ø16	4	E	25	150
MIA408090	M8 x 90 Ø8	20	E	100	600	MIA416145	M16 x 145 Ø16	23	I	25	100
MIA408115	M8 x 115 Ø8	45	G	100	400	MIA416170	M16 x 170 Ø16	48	K	25	75
MIA410070	M10 x 70 Ø10	3	C	100	400	• MIA420120	M20 x 120 Ø20	5	G	20	80
MIA410090	M10 x 90 Ø10	10	E	100	400	MIA420170	M20 x 170 Ø20	23	K	20	80
MIA410120	M10 x 120 Ø10	40	G	50	300	MIA420220	M20 x 220 Ø20	73	O	20	60
MIA410150	M10 x 150 Ø10	70	I	50	200						

• Non assessed sizes. Resistance values and installation data are not applicable to these references. For further information, please contact Technical Department.



Through-bolt expansion anchor with controlled torque, for use in non cracked concrete

MTA

Zinc-plated shaft. Zinc-plated clip.



PRODUCT INFORMATION

DESCRIPTION

Metallic anchor, with male thread, expansion by controlled torque.

OFFICIAL DOCUMENTATION

• Not available.

SIZES

M6x45 to M24x260.

DESIGN LOAD RANGE

From 5,1 to 36,3 kN.



BASE MATERIAL

Concrete class from C20/25 to C50/60 non-cracked.



Stone



Concrete



Reinforced concrete

ASSESSMENTS

• Not available.

CHARACTERISTICS AND BENEFITS

- Easy installation.
- Use in non-cracked concrete.
- Use for medium-heavy duty loads.
- Pre-installation or through the drill-hole of the fixture.
- Variety of lengths and diameters: flexibility in assembly.
- For static and quasi-static loads.
- Available at INDEXcal.



MATERIALS

Shaft: Cold-formed steel, zinc-plated $\geq 5 \mu\text{m}$.

Washer: DIN 125 or DIN 9021, zinc-plated $\geq 5 \mu\text{m}$.

Nut: DIN 934, zinc-plated $\geq 5 \mu\text{m}$.

Clip: Cold-formed steel, zinc-plated $\geq 40 \mu\text{m}$.



APPLICATIONS

- Shelving.
- Pipe supports.
- Urban fitments.
- Fences.
- Common fixings.
- Railings.
- Balconies.



MECHANICAL PROPERTIES

			M6	M8	M10	M12	M14	M16	M20	M24
Cone area section										
A_s	(mm ²)	Cone area section	14,5	25,5	46,5	68,0	100,2	122,6	216,3	299,57
$f_{u,s}$	(N/mm ²)	Characteristic tension resistance	510	510	510	490	490	490	460	460
$f_{y,s}$	(N/mm ²)	Yield strength	440	440	440	410	410	410	375	375
Threaded area section										
A_s	(mm ²)	Cone area section	20,1	36,6	58,0	84,3	115,0	157,0	245,0	353
$f_{u,s}$	(N/mm ²)	Characteristic tension resistance	510	510	510	490	490	490	490	490
$f_{y,s}$	(N/mm ²)	Yield Strength	440	440	440	410	410	410	410	410

INSTALLATION DATA

SIZE			M6	M8	M10	M12	M14	M16	M20	M24
Code			AM06XXX	AM08XXX	AM10XXX	AM12XXX	AM14XXX	AM16XXX	AM20XXX	AM24XXX
d_0	Nominal diameter of drill bit	[mm]	6	8	10	12	14	16	20	24
T_{ins}	Installation torque moment	[Nm]	7	20	35	60	90	120	240	250
$d_{f\leq}$	Diameter of clearance hole in the fixture	[mm]	7	9	12	14	16	18	22	26
h_1	Minimum drill hole depth	[mm]	55	65	75	85	100	110	135	155
h_{nom}	Installation depth	[mm]	49,5	59,5	66,5	77	91	103,5	125	143
h_{ef}	Effective embedment depth	[mm]	40	48	55	65	75	84	103	125
h_{min}	Minimum base material thickness	[mm]	100	100	110	130	150	168	206	250
t_{fix}	Maximum thickness of fixture	[mm]	L - 58	L - 70	L - 80	L - 92	L - 108	L - 122	L - 147	L-170
$s_{cr,N}$	Critical spacing	[mm]	120	144	165	195	225	252	309	375
$c_{cr,N}$	Critical edge distance	[mm]	60	72	83	98	113	126	155	187,5
$s_{cr,sp}$	Critical distance (splitting)	[mm]	160	192	220	260	300	280	360	560
$c_{cr,sp}$	Critical edge distance (splitting)	[mm]	80	96	110	130	150	140	180	280
s_{min}	Minimum spacing	[mm]	35	40	50	70	80	90	135	125
c_{min}	Minimum edge distance	[mm]	35	40	50	70	80	90	135	125
SW	Installation wrench		10	13	17	19	22	24	30	36

*L = Total anchor length

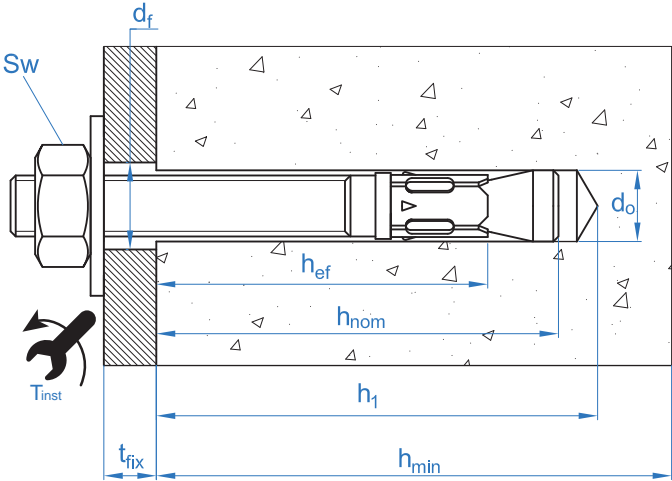



Code	INSTALLATION PRODUCTS
	Hammer drill
BHDSXXXXX	Concrete Drill bits
MOBOMBA	Blow pump
MORCEPKIT	Cleaning Brush
DOMTAXX	Installation hammering tool
	Torque wrench
	Hexagonal socket

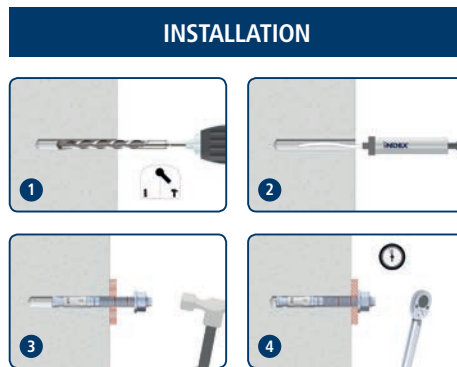

Resistances in C20/25 concrete for an isolated anchor, without effects of edge distance or spacing

Characteristic Resistance N_{Rk} and V_{Rk}																	
TENSION									SHEAR								
Size	M6	M8	M10	M12	M14	M16	M20	M24	Size	M6	M8	M10	M12	M14	M16	M20	M24
N_{Rk} [kN]	7,4	13,0	19,0	26,4	32,8	38,8	52,7	50,0	V_{Rk} [kN]	5,1	9,3	14,7	20,6	28,1	38,4	56,3	84,7

Design Resistance N_{Rd} and V_{Rd}																	
TENSION									SHEAR								
Size	M6	M8	M10	M12	M14	M16	M20	M24	Size	M6	M8	M10	M12	M14	M16	M20	M24
N_{Rd} [kN]	5,2	9,3	12,6	17,6	21,8	25,9	35,1	27,7	V_{Rd} [kN]	4,0	7,4	11,7	16,4	22,4	30,7	45,0	67,7

Maximum Loads Recommended N_{rec} and V_{rec}																	
TENSION									SHEAR								
Size	M6	M8	M10	M12	M14	M16	M20	M24	Size	M6	M8	M10	M12	M14	M16	M20	M24
N_{rec} [kN]	3,7	6,6	9,0	12,6	15,6	18,5	25,1	19,8	V_{rec} [kN]	2,9	5,3	8,4	11,7	16,0	21,9	32,1	48,4

Simplified calculation method

Simplified version of the calculation method according to ETAG 001, annex C. Resistance has been calculated with data obtained from tests performed by INDEX.

- Influence of concrete strength.
- Influence of edge distance.
- Influence of spacing between anchors.
- Influence of reinforcements.
- Influence of base material thickness.
- Influence of load application angle.
- Valid for a group of two anchors.

The calculation method is based on the following simplification: **Different loads do not act on individual anchors, without eccentricity.**



INDEXcal

For a more accurate calculation and to take more constructive provisions into account, we recommend using our calculation program INDEXcal. It may be easily downloaded from our website www.indexfix.com



MTA

TENSION LOADS

- Steel design resistance: $N_{Rd,s}$
- Pull-out design resistance: $N_{Rd,p} = N_{Rd,p}^o \cdot \Psi_c$
- Concrete cone design resistance: $N_{Rd,c} = N_{Rd,c}^o \cdot \Psi_b \cdot \Psi_{s,N} \cdot \Psi_{c,N} \cdot \Psi_{re,N}$
- Concrete splitting design resistance: $N_{Rd,sp} = N_{Rd,c}^o \cdot \Psi_b \cdot \Psi_{s,sp} \cdot \Psi_{c,sp} \cdot \Psi_{re,N} \cdot \Psi_{h,sp}$

Steel Design resistance									
$N_{Rd,s}$									
Size		M6	M8	M10	M12	M14	M16	M20	M24
N_{Rd}^o	[kN]	5,3	9,5	16,9	23,8	35,1	42,9	71,1	119,5

Pull-out design resistance									
$N_{Rd,p} = N_{Rd,p}^o \cdot \Psi_c$									
Size		M6	M8	M10	M12	M14	M16	M20	M24
$N_{Rd,p}^o$	Non-cracked concrete [kN]	-*	-*	12,6	-*	-*	-*	-*	27,7

* Pull-out failure is not decisive.

Concrete cone design resistance									
$N_{Rd,c} = N_{Rd,c}^o \cdot \Psi_b \cdot \Psi_{s,N} \cdot \Psi_{c,N} \cdot \Psi_{re,N}$									
Concrete splitting design resistance*									
$N_{Rd,sp} = N_{Rd,c}^o \cdot \Psi_b \cdot \Psi_{s,sp} \cdot \Psi_{c,sp} \cdot \Psi_{re,N} \cdot \Psi_{h,sp}$									
Size		M6	M8	M10	M12	M14	M16	M20	M24
$N_{Rd,c}^o$	Non-cracked concrete [kN]	8,5	11,2	13,7	17,6	21,8	25,9	35,1	39,2

*Concrete splitting design resistance must only be considered for non-cracked concrete.

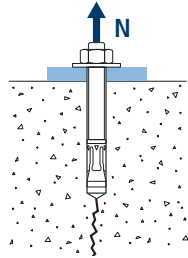
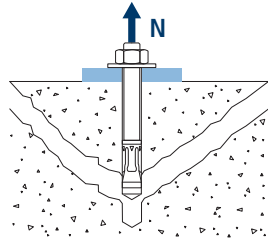
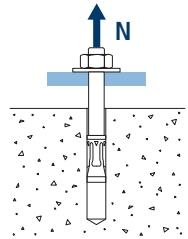
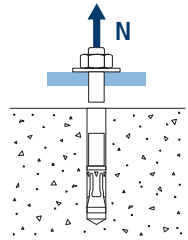



MTA

Coefficients of influence

Influence of concrete strength resistance in pul-out failure ψ_c

		M6	M8	M10	M12	M14	M16	M20	M24	
ψ_c	C 20/25					1,00				
	C 30/37					1,22				
	C 40/50					1,41				
	C 50/60					1,55				

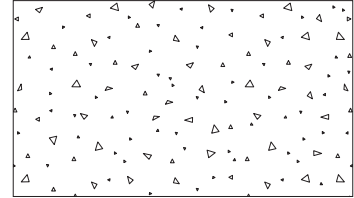
Influence of concrete strength in concrete cone and splitting failure ψ_b

		M6	M8	M10	M12	M14	M16	M20	M24	
ψ_b	C 20/25					1,00				
	C 30/37					1,22				
	C 40/50					1,41				
	C 50/60					1,55				

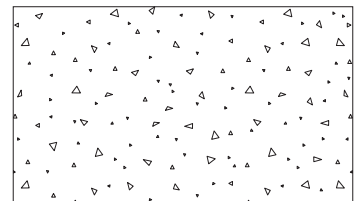

$$\psi_b = \sqrt{\frac{f_{ck,cube}}{25}} \geq 1$$



MTA

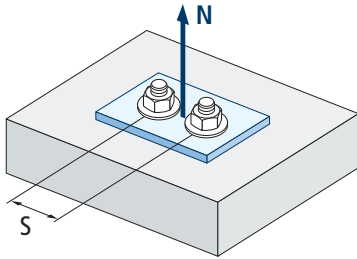

$$\psi_{s,N} = 0,5 + \frac{s}{2 \cdot s_{cr,N}} \leq 1$$

Influence of spacing (concrete cone) $\psi_{s,N}$								
s [mm]	MTA							
	M6	M8	M10	M12	M14	M16	M20	M24
35	0,65							
40	0,67	0,64						
50	0,71	0,67	0,65					
55	0,73	0,69	0,67					
60	0,75	0,71	0,68					
65	0,77	0,73	0,70					
70	0,79	0,74	0,71	0,68				
80	0,83	0,78	0,74	0,71				
85	0,85	0,80	0,76	0,72	0,69			
90	0,88	0,81	0,77	0,73	0,70			
100	0,92	0,85	0,80	0,76	0,72	0,70		
105	0,94	0,86	0,82	0,77	0,73	0,71		
110	0,96	0,88	0,83	0,78	0,74	0,72		
120	1,00	0,92	0,86	0,81	0,77	0,74		
125		0,93	0,88	0,82	0,78	0,75		0,67
126		0,94	0,88	0,82	0,78	0,75		0,67
128		0,94	0,89	0,83	0,78	0,75		0,67
130		0,95	0,89	0,83	0,79	0,76		0,67
135		0,97	0,91	0,85	0,80	0,77	0,72	0,68
144		1,00	0,94	0,87	0,82	0,79	0,73	0,69
150			0,95	0,88	0,83	0,80	0,74	0,70
165			1,00	0,92	0,87	0,83	0,77	0,72
170				0,94	0,88	0,84	0,78	0,73
180				0,96	0,90	0,86	0,79	0,74
195				1,00	0,93	0,89	0,82	0,76
200					0,94	0,90	0,82	0,77
210					0,97	0,92	0,84	0,78
220					0,99	0,94	0,86	0,79
225					1,00	0,95	0,86	0,80
252						1,00	0,91	0,84
255							0,91	0,84
260							0,92	0,85
300							0,99	0,90
309							1,00	0,91
310								0,91
375								1,00

Value without reduction = 1



Influence of spacing (concrete splitting) $\psi_{s,sp}$								
s [mm]	MTA							
	M6	M8	M10	M12	M14	M16	M20	M24
35	0,61							
40	0,63	0,60						
50	0,66	0,63	0,61					
55	0,67	0,64	0,63					
60	0,69	0,66	0,64					
65	0,70	0,67	0,65					
70	0,72	0,68	0,66	0,63				
80	0,75	0,71	0,68	0,65	0,63			
85	0,77	0,72	0,69	0,66	0,64			
90	0,78	0,73	0,70	0,67	0,65	0,66		
100	0,81	0,76	0,73	0,69	0,67	0,68		
110	0,84	0,79	0,75	0,71	0,68	0,70		
125	0,89	0,83	0,78	0,74	0,71	0,72		0,61
128	0,90	0,83	0,79	0,75	0,71	0,73		0,61
135	0,92	0,85	0,81	0,76	0,73	0,74	0,69	0,62
140	0,94	0,86	0,82	0,77	0,73	0,75	0,69	0,63
150	0,97	0,89	0,84	0,79	0,75	0,77	0,71	0,63
160	1,00	0,92	0,86	0,81	0,77	0,79	0,72	0,64
165		0,93	0,88	0,82	0,78	0,79	0,73	0,65
168		0,94	0,88	0,82	0,78	0,80	0,73	0,65
180		0,97	0,91	0,85	0,80	0,82	0,75	0,66
192		1,00	0,94	0,87	0,82	0,84	0,77	0,67
200			0,95	0,88	0,83	0,86	0,78	0,68
210			0,98	0,90	0,85	0,88	0,79	0,69
220			1,00	0,92	0,87	0,89	0,81	0,70
260				1,00	0,93	0,96	0,86	0,73
280					0,97	1,00	0,89	0,75
288					0,98		0,90	0,76
300					1,00		0,92	0,77
336							0,97	0,80
350							0,99	0,81
360							1,00	0,82
412								0,87
425								0,88
500								0,95
510								0,96
560								1,00

Invalid value

Value without reduction = 1

MTA

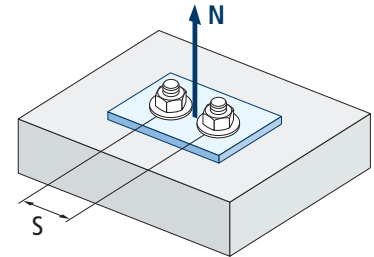

$$\psi_{s,sp} = 0,5 + \frac{s}{2 \cdot s_{cr,sp}} \leq 1$$



MTA

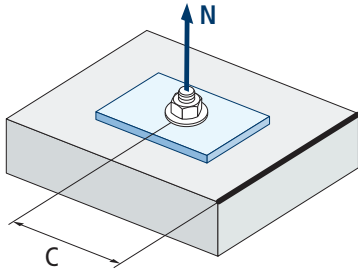

$$\psi_{c,sp} = 0,35 + \frac{0,5 \cdot c}{C_{cr,sp}} + \frac{0,15 \cdot c^2}{C_{cr,sp}^2} \leq 1$$

Influence of concrete edge distance (splitting) $\psi_{c,sp}$								
c [mm]	MTA							
	M6	M8	M10	M12	M14	M16	M20	M24
35	0,60							
40	0,64	0,58						
50	0,72	0,65	0,61					
60	0,81	0,72	0,67					
65	0,86	0,76	0,70					
70	0,90	0,79	0,73	0,66				
75	0,95	0,83	0,76	0,69				
80	1,00	0,87	0,79	0,71	0,66			
83		0,89	0,81	0,73	0,67			
84		0,90	0,82	0,74	0,68			
85		0,91	0,83	0,74	0,68			
90		0,95	0,86	0,77	0,70	0,73		
96		1,00	0,90	0,80	0,73	0,76		
100			0,93	0,82	0,75	0,78		
105			0,96	0,85	0,77	0,81		
110			1,00	0,88	0,80	0,84		
125				0,97	0,87	0,92		0,60
128				0,99	0,89	0,93		0,61
130				1,00	0,90	0,94		0,61
135					0,92	0,97	0,81	0,63
140					0,95	1,00	0,83	0,64
144					0,97		0,85	0,65
150					1,00		0,87	0,66
168							0,95	0,70
175							0,98	0,72
180							1,00	0,73
206								0,80
213								0,82
250								0,92
255								0,93
280								1,00

Invalid value

Value without reduction = 1



Influence of concrete edge distance (concrete cone) $\psi_{c,N}$								
c [mm]	MTA							
	M6	M8	M10	M12	M14	M16	M20	M24
35	0,69							
40	0,75	0,67						
50	0,87	0,77	0,71					
53	0,91	0,80	0,73					
60	1,00	0,87	0,79					
63		0,90	0,82					
65		0,92	0,83					
70		0,98	0,88	0,78				
72		1,00	0,90	0,80				
75			0,92	0,82				
80			0,97	0,86	0,78			
83			1,00	0,88	0,80			
85				0,90	0,81			
90				0,94	0,84	0,78		
98				1,00	0,90	0,83		
100					0,91	0,84		
105					0,94	0,87		
110					0,98	0,90		
113					1,00	0,92		
125						0,99		0,75
126						1,00		0,75
128								0,76
135							0,90	0,79
150							0,97	0,84
155							1,00	0,86
188								1,00

Invalid value

Value without reduction = 1

MTA

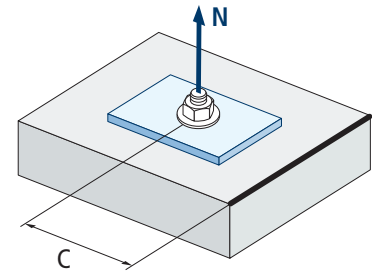

$$\psi_{c,N} = 0,35 + \frac{0,5 \cdot c}{C_{cr,N}} + \frac{0,15 \cdot c^2}{C_{cr,N}^2} \leq 1$$

Influence of reinforcements $\psi_{re,N}$								
$\psi_{re,N}$	MTA							
	M6	M8	M10	M12	M14	M16	M20	M24
	0,70	0,74	0,77	0,82	0,87	0,92	1,00	1,00

*This factor only applies for a high density of reinforcements. If in the area of the anchor there are reinforcements with a distancing of ≥ 150 mm (any diameter) or with a diameter ≤ 10 mm and a distancing of ≥ 100 mm, a $f_{re,N} = 1$ factor may be applied.

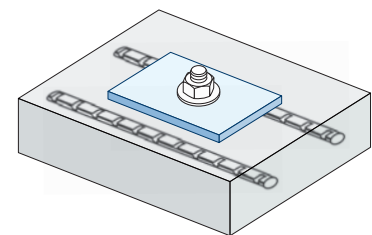

$$\psi_{re,N} = 0,5 + \frac{h_{ef}}{200} \leq 1$$

Influence of base material thickness $\psi_{h,sp}$											
$\psi_{h,sp}$	MTA										
	h/hef	2,00	2,20	2,40	2,60	2,80	3,00	3,20	3,40	3,60	$\geq 3,68$
	$\psi_{h,sp}$	1,00	1,07	1,13	1,19	1,25	1,31	1,37	1,42	1,48	1,50

$$\psi_{h,sp} = \left(\frac{h}{2 \cdot h_{ef}} \right)^{2/3} \leq 1,5$$

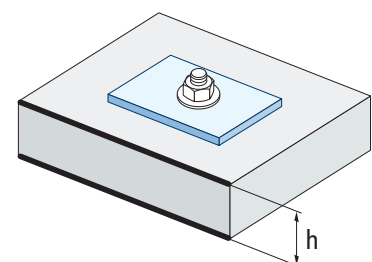



MTA

SHEAR LOADS

- Steel design resistance without lever arm: $V_{Rd,s}$
- Pry-out design resistance: $V_{Rd,cp} = k \cdot N_{Rd,c}^o$
- Concrete edge design resistance: $V_{Rd,c} = V_{Rd,c}^o \cdot \psi_b \cdot \psi_{se,V} \cdot \psi_{c,V} \cdot \psi_{re,V} \cdot \psi_{\alpha,V} \cdot \psi_{h,V}$

Steel design resistance									
$V_{Rd,s}$									
Size		M6	M8	M10	M12	M14	M16	M20	M24
$V_{Rd,s}$	[kN]	4,1	7,4	11,8	16,5	22,5	30,7	45,0	65,0

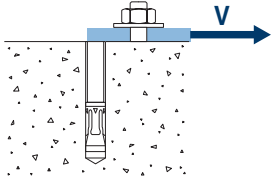

Pry-out design resistance*									
$V_{Rd,cp} = k \cdot N_{Rd,c}^o$									
Size		M6	M8	M10	M12	M14	M16	M20	M24
k		1	1	1	2	2	2	2	2

* $N_{Rd,c}^o$ Concrete cone design resistance for tension loads

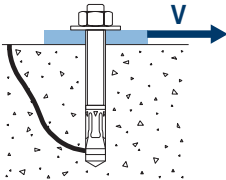

Concrete edge resistance										
$V_{Rd,c} = V_{Rd,c}^o \cdot \psi_b \cdot \psi_{se,V} \cdot \psi_{c,V} \cdot \psi_{re,V} \cdot \psi_{\alpha,V} \cdot \psi_{h,V}$										
Size		M6	M8	M10	M12	M14	M16	M20	M24	
$V_{Rd,c}^o$	Non-cracked concrete	[kN]	4,6	6,2	7,7	10,2	12,9	15,6	21,8	29,2

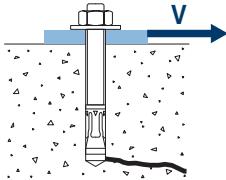



MTA

Coefficients of influence

Influence of concrete strength in concrete edge failure Ψ_b										
		M6	M8	M10	M12	M14	M16	M20	M24	
Ψ_b	C 20/25	1,00								
	C 30/37	1,22								
	C 40/50	1,41								
	C 50/60	1,55								

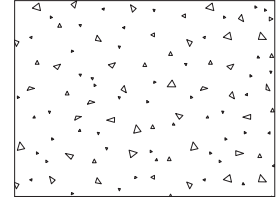

$$\Psi_b = \sqrt{\frac{f_{ck,cube}}{25}} \geq 1$$

Influence of edge distance and spacing $\Psi_{se,V}$																		
FOR ONE ANCHOR ONLY																		
c/h_{ef}	0,50	0,75	1,00	1,25	1,50	1,75	2,00	2,25	2,50	2,75	3,00	3,25	3,50	3,75	4,00	4,50	5,00	
Isolated	0,35	0,65	1,00	1,40	1,84	2,32	2,83	3,38	3,95	4,56	5,20	5,86	6,55	7,26	8,00	9,55	11,18	
FOR TWO ANCHORS																		
c/h_{ef}	0,50	0,75	1,00	1,25	1,50	1,75	2,00	2,25	2,50	2,75	3,00	3,25	3,50	3,75	4,00	4,50	5,00	
s/c	1,0	0,24	0,43	0,67	0,93	1,22	1,54	1,89	2,25	2,64	3,04	3,46	3,91	4,37	4,84	5,33	6,36	7,45
	1,5	0,27	0,49	0,75	1,05	1,38	1,74	2,12	2,53	2,96	3,42	3,90	4,39	4,91	5,45	6,00	7,16	8,39
	2,0	0,29	0,54	0,83	1,16	1,53	1,93	2,36	2,81	3,29	3,80	4,33	4,88	5,46	6,05	6,67	7,95	9,32
	2,5	0,32	0,60	0,92	1,28	1,68	2,12	2,59	3,09	3,62	4,18	4,76	5,37	6,00	6,66	7,33	8,75	10,25
	$\geq 3,0$	0,35	0,65	1,00	1,40	1,84	2,32	2,83	3,38	3,95	4,56	5,20	5,86	6,55	7,26	8,00	9,55	11,18

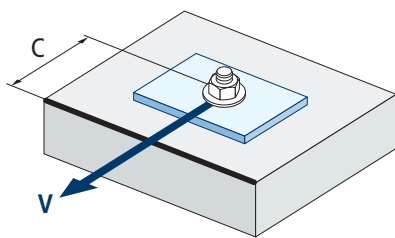

$$\Psi_{se,V} = \left(\frac{c}{h_{ef}}\right)^{1,5}$$

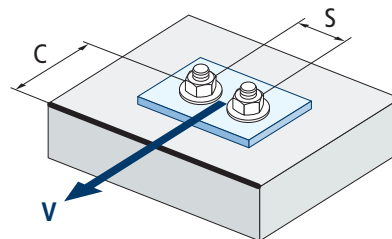

$$\Psi_{se,V} = \left(\frac{c}{h_{ef}}\right)^{1,5} \cdot \left(1 + \frac{s}{3 \cdot c}\right) \cdot 0,5 \leq \left(\frac{c}{h_{ef}}\right)^{1,5}$$



MTA

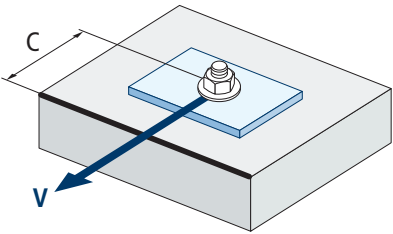

$$\psi_{c,v} = \left(\frac{d}{c} \right)^{0,20}$$

Influence of concrete edge distance $\psi_{c,v}$								
c [mm]	MTA							
	M6	M8	M10	M12	M14	M16	M20	M24
35	0,70							
40	0,68	0,72						
45	0,67	0,71						
50	0,65	0,69	0,72					
55	0,64	0,68	0,71					
60	0,63	0,67	0,70					
70	0,61	0,65	0,68	0,70				
80	0,60	0,63	0,66	0,68	0,71			
85	0,59	0,62	0,65	0,68	0,70			
90	0,58	0,62	0,64	0,67	0,69	0,71		
100	0,57	0,60	0,63	0,65	0,67	0,69		
105	0,56	0,60	0,62	0,65	0,67	0,69		
110	0,56	0,59	0,62	0,64	0,66	0,68		
120	0,55	0,58	0,61	0,63	0,65	0,67		
125	0,54	0,58	0,60	0,63	0,65	0,66		0,72
128	0,54	0,57	0,60	0,62	0,64	0,66		0,72
130	0,54	0,57	0,60	0,62	0,64	0,66		0,71
135	0,54	0,57	0,59	0,62	0,64	0,65	0,68	0,71
140	0,53	0,56	0,59	0,61	0,63	0,65	0,68	0,70
150	0,53	0,56	0,58	0,60	0,62	0,64	0,67	0,69
160	0,52	0,55	0,57	0,60	0,61	0,63	0,66	0,68
170	0,51	0,54	0,57	0,59	0,61	0,62	0,65	0,68
175	0,51	0,54	0,56	0,59	0,60	0,62	0,65	0,67
180	0,51	0,54	0,56	0,58	0,60	0,62	0,64	0,67
190	0,50	0,53	0,55	0,58	0,59	0,61	0,64	0,66
200	0,50	0,53	0,55	0,57	0,59	0,60	0,63	0,65
210	0,49	0,52	0,54	0,56	0,58	0,60	0,62	0,65
220	0,49	0,52	0,54	0,56	0,58	0,59	0,62	0,64
230	0,48	0,51	0,53	0,55	0,57	0,59	0,61	0,64
240	0,48	0,51	0,53	0,55	0,57	0,58	0,61	0,63
250	0,47	0,50	0,53	0,54	0,56	0,58	0,60	0,63
260	0,47	0,50	0,52	0,54	0,56	0,57	0,60	0,62
270	0,47	0,49	0,52	0,54	0,55	0,57	0,59	0,62
280	0,46	0,49	0,51	0,53	0,55	0,56	0,59	0,61
290	0,46	0,49	0,51	0,53	0,55	0,56	0,59	0,61
300	0,46	0,48	0,51	0,53	0,54	0,56	0,58	0,60



Influence of reinforcements $\Psi_{re,v}$			
	Without perimetral reinforcements	Perimetral reinforcements $\geq \text{Ø}12 \text{ mm}$	Perimetral reinforcements with brackets $\leq 100 \text{ mm}$
Non-cracked concrete	1	1	1

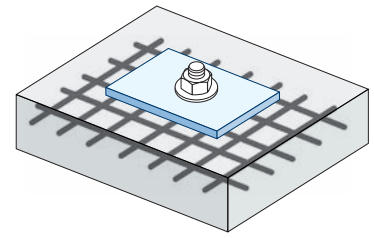

Influence of load application angle $\Psi_{\alpha,v}$										
Angle, α (°)	0°	10°	20°	30°	40°	50°	60°	70°	80°	90°
$\Psi_{\alpha,v}$	1,00	1,01	1,05	1,13	1,24	1,40	1,64	1,97	2,32	2,50

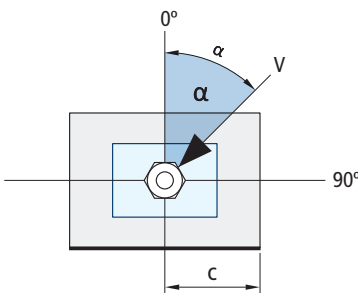

$$\Psi_{\alpha,v} = \sqrt{\frac{1}{(\cos \alpha_v)^2 + \left(\frac{\sin \alpha_v}{2,5}\right)^2}} \geq 1$$

Influence of base material thickness $\Psi_{h,v}$										
MTA										
h/c	0,15	0,30	0,45	0,60	0,75	0,90	1,05	1,20	1,35	$\geq 1,5$
$\Psi_{h,v}$	0,32	0,45	0,55	0,63	0,71	0,77	0,84	0,89	0,95	1,00

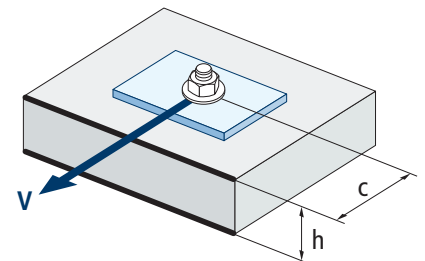

$$\Psi_{h,v} = \left(\frac{h}{1,5 \cdot c}\right)^{0,5} \geq 1,0$$



MTA

RANGE

Code	Size	Maximum thickness of fixture			Code	Size	Maximum thickness of fixture		
AM06045	M6 x 45 Ø6	1	200	1.200	AM08115	M8 x 115 Ø8	45	100	400
AM06055	M6 x 55 Ø6	11	200	1.200	AM08120	M8 x 120 Ø8	50	100	400
AM06060	M6 x 60 Ø6	2	200	1.200	AM08130	M8 x 130 Ø8	60	100	400
AM06065	M6 x 65 Ø6	7	200	1.200	AM08155	M8 x 155 Ø8	85	100	200
AM06070	M6 x 70 Ø6	12	200	1.200	AM10065	M10 x 65 Ø10	1	100	400
AM06080	M6 x 80 Ø6	22	200	1.200	AM10070	M10 x 70 Ø10	3	100	400
AM06085	M6 x 85 Ø6	27	200	1.200	AM10080	M10 x 80 Ø10	13	100	400
AM06090	M6 x 90 Ø6	32	200	1.200	AM10090	M10 x 90 Ø10	10	100	400
AM06100	M6 x 100 Ø6	42	200	800	AM10100	M10 x 100 Ø10	20	100	400
AM06110	M6 x 110 Ø6	52	200	800	AM10120	M10 x 120 Ø10	40	50	300
AM06120	M6 x 120 Ø6	62	100	600	AM10140	M10 x 140 Ø10	60	50	200
AM06130	M6 x 130 Ø6	72	100	600	AM10150	M10 x 150 Ø10	70	50	200
AM06140	M6 x 140 Ø6	82	100	600	AM10160	M10 x 160 Ø10	80	50	200
AM06150	M6 x 150 Ø6	92	100	600	AM10170	M10 x 170 Ø10	90	50	200
AM06160	M6 x 160 Ø6	102	100	400	AM10210	M10 x 210 Ø10	130	50	150
AM06170	M6 x 170 Ø6	112	100	400	AM10230	M10 x 230 Ø10	150	50	100
AM06180	M6 x 180 Ø6	122	100	300	AM12075	M12 x 75 Ø12	5	50	300
AM08050	M8 x 50 Ø8	4	100	800	AM12080	M12 x 80 Ø12	3	50	300
AM08060	M8 x 60 Ø8	3	100	800	AM12090	M12 x 90 Ø12	13	50	200
AM08065	M8 x 65 Ø8	8	100	600	AM12100	M12 x 100 Ø12	8	50	200
AM08075	M8 x 75 Ø8	5	100	600	AM12110	M12 x 110 Ø12	18	50	200
AM08090	M8 x 90 Ø8	20	100	600					

FOTECMTEN19
REV4

INDEX[®]
A PERFECT FIXING

Técnicas Expansivas S.L.
P. I. La Portalada II, C/ Segador, 13
26006 · Logroño (La Rioja) · SPAIN

T. (+34) 941.272.131 · E. info@indexfix.com
www.indexfix.com