



**Technical and Test Institute
for Construction Prague**
Prosecká 811/76a
190 00 Prague
Czech Republic
eota@tzus.cz



Member of



www.eota.eu

European Technical Assessment

**ETA 13/0752
of 16/05/2018**

Technical Assessment Body issuing the ETA: Technical and Test Institute
for Construction Prague

Trade name of the construction product

MO-P steel bonded anchor

**Product family to which the construction
product belongs**

Product area code: 33
Bonded injection type anchor for use
in uncracked concrete

Manufacturer

Index Técnicas Expansivas, S.L.
P.I. La Portalada II C. Segador 13
26006 Logroño
Spain

Manufacturing plant

Index Plant 1

**This European Technical Assessment
contains**

14 pages including 10 Annexes which form
an integral part of this assessment

**This European Technical Assessment is
issued in accordance with regulation
(EU) No 305/2011, on the basis of**

EAD 330499-00-0601

This version replaces

ETA 13/0752 issued on 11/06/2013

Translations of this European Technical Assessment in other languages shall fully correspond to the original issued document and should be identified as such.

Communication of this European Technical Assessment, including transmission by electronic means, shall be in full (excepted the confidential Annex(es) referred to above). However, partial reproduction may be made, with the written consent of the issuing Technical Assessment Body - Technical and Test Institute for Construction Prague. Any partial reproduction has to be identified as such.

1. Technical description of the product

The MO-P, MO-PP (stone color) with steel elements is bonded anchor (injection type). Steel elements can be galvanized or stainless steel.

Steel element is placed into a drilled hole filled with injection mortar. The steel element is anchored via the bond between metal part, injection mortar and concrete. The anchor is intended to be used with embedment depth from 8 diameters to 12 diameters.

The illustration and the description of the product are given in Annex A.

2. Specification of the intended use in accordance with the applicable EAD

The performances given in Section 3 are only valid if the anchor is used in compliance with the specifications and conditions given in Annex B.

The provisions made in this European Technical Assessment are based on an assumed working life of the anchor of 50 years. The indications given on the working life cannot be interpreted as a guarantee given by the producer, but are to be regarded only as a means for choosing the products in relation to the expected economically reasonable working life of the works.

3. Performance of the product and references to the methods used for its assessment

3.1 Mechanical resistance and stability (BWR 1)

Essential characteristic	Performance
Resistance to steel failure (tension)	See Annex C1
Resistance to combined pull-out and concrete failure	See Annex C1
Resistance to concrete cone failure	See Annex C1
Edge distance to prevent splitting under load	See Annex C1
Robustness	See Annex C1
Maximum setting torque moment	See Annex B4
Minimum edge distance and spacing	See Annex B4
Resistance to steel failure (shear)	See Annex C2
Resistance to pry-out failure	See Annex C2
Resistance to concrete edge failure	See Annex C2
Displacements under short term and long term loading	See Annex C3
Durability of metal parts	See Annex A3

3.2 Hygiene, health and environment (BWR 3)

No performance determined.

3.3 General aspects relating to fitness for use

Durability and serviceability are only ensured if the specifications of intended use according to Annex B 1 are kept.

4. Assessment and verification of constancy of performance (AVCP) system applied with reference to its legal base

According to the Decision 96/582/EC of the European Commission¹ the system of assessment verification of constancy of performance (see Annex V to Regulation (EU) No 305/2011) given in the following table apply.

¹ Official Journal of the European Communities L 254 of 08.10.1996

Product	Intended use	Level or class	System
Metal anchors for use in concrete	For fixing and/or supporting to concrete, structural elements (which contributes to the stability of the works) or heavy units.	-	1

5. Technical details necessary for the implementation of the AVCP system, as provided in the applicable EAD

5.1 Tasks of the manufacturer

The manufacturer may only use raw materials stated in the technical documentation of this European Technical Assessment.

The factory production control shall be in accordance with the control plan which is a part of the technical documentation of this European Technical Assessment. The control plan is laid down in the context of the factory production control system operated by the manufacturer and deposited at Technical and Test Institute for Construction Prague.² The results of factory production control shall be recorded and evaluated in accordance with the provisions of the control plan.

5.2 Tasks of the notified bodies

The notified body shall retain the essential points of its actions referred to above and state the results obtained and conclusions drawn in a written report.

The notified certification body involved by the manufacturer shall issue a certificate of constancy of performance of the product stating the conformity with the provisions of this European Technical Assessment.

In cases where the provisions of the European Technical Assessment and its control plan are no longer fulfilled the notified body shall withdraw the certificate of constancy of performance and inform Technical and Test Institute for Construction Prague without delay.

Issued in Prague on 16.05.2018

By

Ing. Mária Schaan

Head of the Technical Assessment Body

² The control plan is a confidential part of the documentation of the European Technical Assessment, but not published together with the ETA and only handed over to the approved body involved in the procedure of AVCP.

Threaded rod

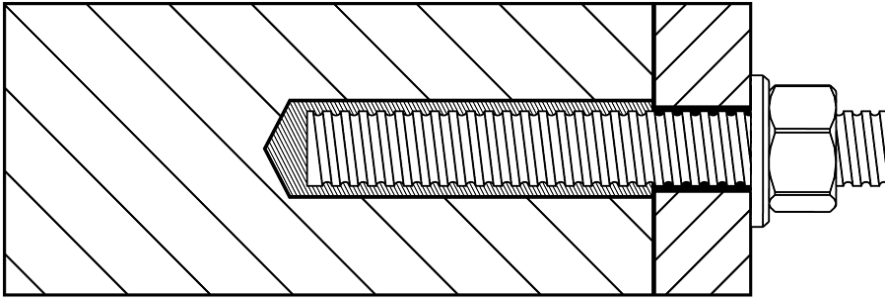

MO-P steel bonded anchor

Product description
Installed conditions

Annex A 1

Coaxial cartridge (CC)

MO-P

150 ml
380 ml
400 ml
410 ml

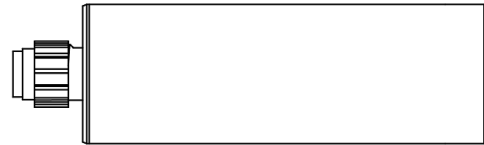

Side by side cartridge (SBS)

MO-P

350 ml
825 ml

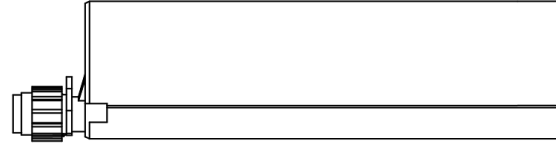

Two part foil in a single piston component cartridge (FCC)

MO-P

150 ml
170 ml
300 ml
550 ml
850 ml

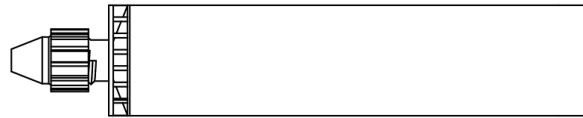

Marking of the mortar cartridges

Identifying mark of the producer, Trade name, Charge code number, Storage life, Curing and processing time

Mixing nozzle

KW

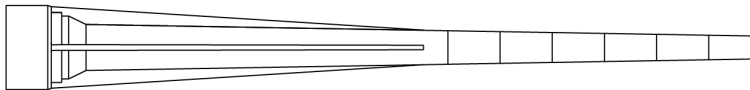

RC

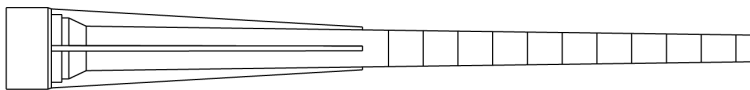

RM

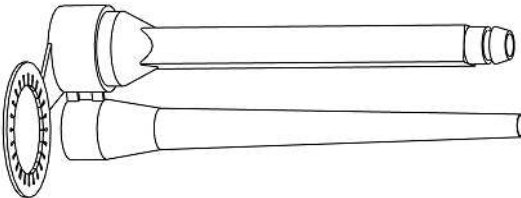

TB

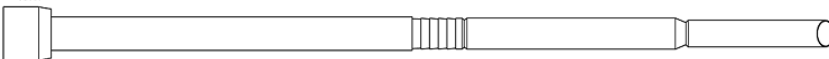

KR for 850

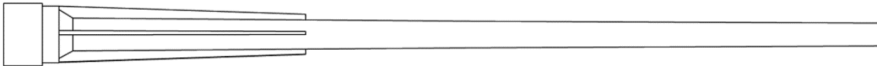

MO-P steel bonded anchor

Product description

Injection system

Annex A 2

Threaded rod M8, M10, M12, M16, M20, M24

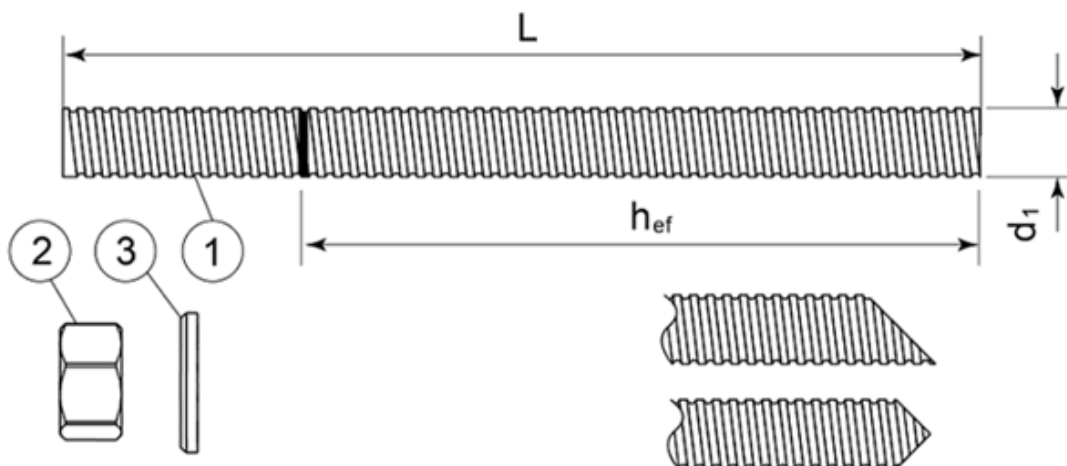

Standard commercial threaded rod with marked embedment depth

Part	Designation	Material
Steel, zinc plated $\geq 5 \mu\text{m}$ acc. to EN ISO 4042 or Steel, Hot-dip galvanized $\geq 40 \mu\text{m}$ acc. to EN ISO 1461 and EN ISO 10684		
1	Anchor rod	Steel, EN 10087 or EN 10263 Property class 5.8, 8.8, 10.9* EN ISO 898-1
2	Hexagon nut EN ISO 4032	According to threaded rod, EN 20898-2
3	Washer EN ISO 887, EN ISO 7089, EN ISO 7093 or EN ISO 7094	According to threaded rod
Stainless steel		
1	Anchor rod	Material: A2-70, A4-70, A4-80, EN ISO 3506
2	Hexagon nut EN ISO 4032	According to threaded rod
3	Washer EN ISO 887, EN ISO 7089, EN ISO 7093 or EN ISO 7094	According to threaded rod
High corrosion resistant steel 1.4529		
1	Anchor rod	Material: 1.4529, EN 10088-1
2	Hexagon nut EN ISO 4032	According to threaded rod
3	Washer EN ISO 887, EN ISO 7089, EN ISO 7093 or EN ISO 7094	According to threaded rod

*Galvanized rod of high strength are sensitive to hydrogen induced brittle failure

MO-P steel bonded anchor	Annex A 3
Product description Threaded rod and materials	

Specifications of intended use

Anchorage subject to:

- Static and quasi-static load.

Base materials

- Uncracked concrete.
- Reinforced or unreinforced normal weight concrete of strength class C20/25 at minimum and C50/60 at maximum according EN 206-1:2000-12.

Temperature range:

- -40°C to +80°C (max. short. term temperature +80°C and max. long term temperature +50°C)

Use conditions (Environmental conditions)

- (X1) Structures subject to dry internal conditions (zinc coated steel, stainless steel, high corrosion resistance steel).
- (X2) Structures subject to external atmospheric exposure (including industrial and marine environment) and to permanently damp internal condition, if no particular aggressive conditions exist (stainless steel A4, high corrosion resistant steel).
- (X3) Structures subject to external atmospheric exposure and to permanently damp internal condition, if other particular aggressive conditions exist (high corrosion resistant steel).

Note: Particular aggressive conditions are e.g. permanent, alternating immersion in seawater or the splash zone of seawater, chloride atmosphere of indoor swimming pools or atmosphere with extreme chemical pollution (e.g. in desulphurization plants or road tunnels where de-icing materials are used).

Concrete conditions:

- I1 – installation in dry or wet (water saturated) concrete or flooded hole.
- I2 – installation in water-filled (not sea water) and use in service in dry or wet concrete

Design:

- The anchorages are designed in accordance with the EN 1992-4 or EOTA Technical Report TR 055 under the responsibility of an engineer experienced in anchorages and concrete work.
- Verifiable calculation notes and drawings are prepared taking account of the loads to be anchored. The position of the anchor is indicated on the design drawings.

Installation:

- Hole drilling by hammer drill mode.
- Anchor installation carried out by appropriately qualified personnel and under the supervision of the person responsible for technical matters of the site.

Installation direction:

- D3 – downward and horizontal and upwards (e.g. overhead) installation

MO-P steel bonded anchor

Intended use
Specifications

Annex B 1

Applicator gun

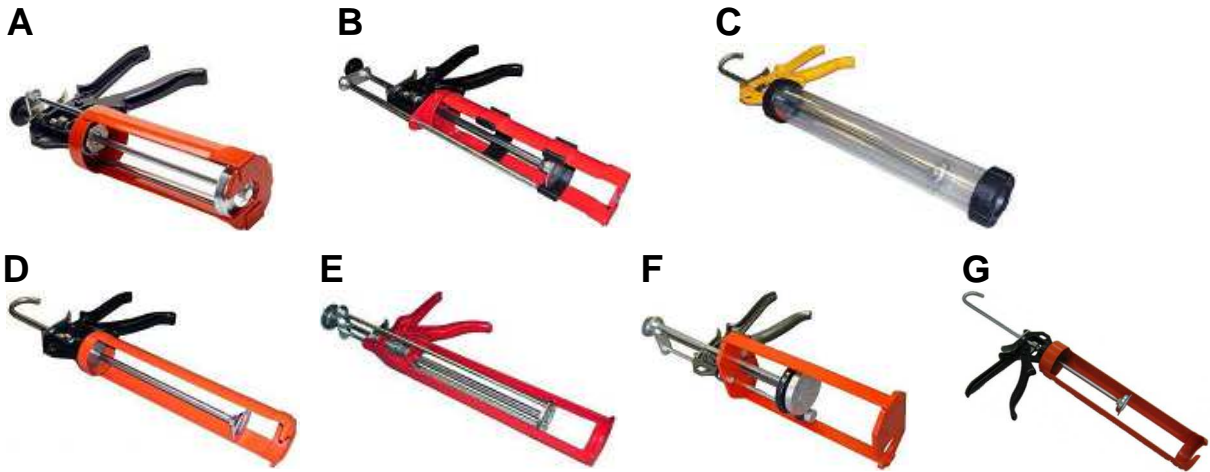

Applicator gun	A	B	C	D	E	F	G
Cartridge	Coaxial 380ml 400ml 410ml	Side by side 350ml	Foil capsule 150ml 300ml 550ml	Foil capsule 150ml 300ml	Coaxial 150ml	Side by side 825ml	Foil capsule 850ml

Cleaning brush

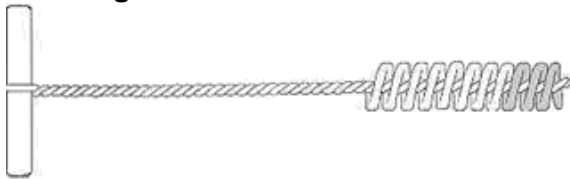

MO-P steel bonded anchor

Intended use
Applicator guns
Cleaning brush

Annex B 2

Installation procedure

1. Drill the hole to the correct diameter and depth. This can be done with either a rotary percussion or rotary hammer drilling machine depending upon the substrate.

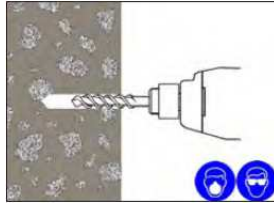

2. Thoroughly clean the hole in the following sequence using the Brush with the required extensions and a Blow Pump.

Blow Clean x2.
Brush Clean x2.
Blow Clean x2.
Brush Clean x2.
Blow Clean x2.

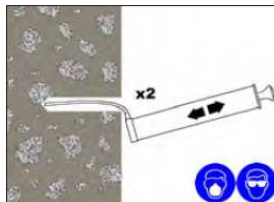
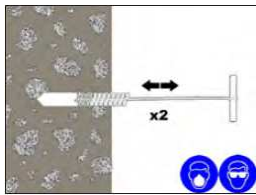
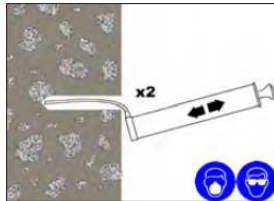
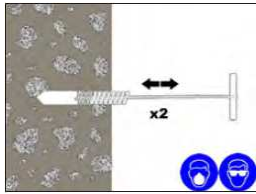
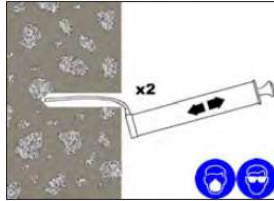

If the hole collects water after the initial cleaning this water must be removed before injecting the resin.

3. Select the appropriate static mixer nozzle for the installation, open the cartridge/foil and screw onto the mouth of the cartridge. Insert the cartridge into the correct applicator gun.
4. Extrude the first part of the cartridge to waste until an even colour has been achieved without streaking in the resin.

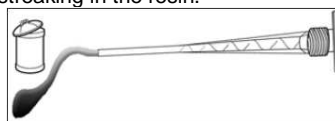

5. If necessary, cut the extension tube to the depth of the hole and push onto the end of the mixer nozzle, and (for threaded bar 16mm dia. or more) fit the correct resin stopper to the other end. Attach extension tubing and resin stopper.

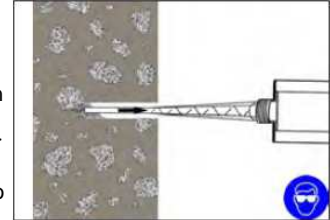

6. Insert the mixer nozzle (resin stopper / extension tube if applicable) to the bottom of the hole. Begin to extrude the resin and slowly withdraw the mixer nozzle from the hole ensuring that there are no air voids as the mixer nozzle is withdrawn. Fill the hole to approximately 1/2 to 3/4 full and remove the mixer nozzle completely.

7. Insert the clean threaded bar, free from oil or other release agents, to the bottom of the hole using a back and forth twisting motion ensuring all the threads are thoroughly coated. Adjust to the correct position within the stated working time.



8. Any excess resin should be expelled from the hole evenly around the steel element showing that the hole is full. This excess resin should be removed from around the mouth of the hole before it sets.

9. Leave the anchor to cure. Do not disturb the anchor until the appropriate loading/curing time has elapsed depending on the substrate conditions and ambient temperature.

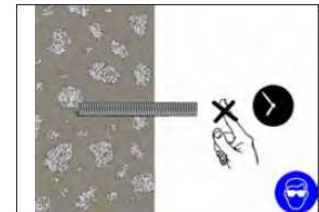

10. Attach the fixture and tighten the nut to the recommended torque.

Do not overtighten.

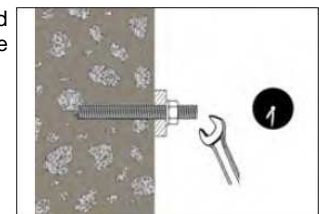

MO-P steel bonded anchor

Intended use
 Installation procedure

Annex B 3

Table B1: Installation parameter

Size			M8	M10	M12	M16	M20	M24
Nominal drill hole diameter	$\varnothing d_0$	[mm]	10	12	14	18	22	26
Diameter of cleaning nylon brush	d_b	[mm]	14	14	20	20	29	29
Torque moment	$\max T_{fix}$	[Nm]	10	20	40	80	150	200
Depth of drill hole for $h_{ef,min}$	$h_0 = h_{ef}$	[mm]	64	80	96	128	160	192
Depth of drill hole for $h_{ef,max}$	$h_0 = h_{ef}$	[mm]	96	120	144	192	240	288
Minimum edge distance	c_{min}	[mm]	35	40	50	65	80	96
Minimum spacing	s_{min}	[mm]	35	40	50	65	80	96
Minimum thickness of member	h_{min}	[mm]	$h_{ef} + 30 \text{ mm} \geq 100 \text{ mm}$				$h_{ef} + 2d_0$	

Table B2: Cleaning

All diameters
- 2 x blowing
- 2 x brushing
- 2 x blowing
- 2 x brushing
- 2 x blowing

Table B3: Minimum curing time

Resin cartridge temperature [°C]	T Work [mins]	Base material Temperature [°C]	T Load [mins]
min +5	18	min +5	120
+5 to +10	12	+5 to +10	
+10 to +20	6	+10 to +20	80
+20 to +25	4	+20 to +25	40
+25 to +30	3	+25 to +30	30
+30 to +35	2	+30 to +35	20
+35 to +40	1,5	+35 to +40	15
+40		+40	10

T work is typical gel time at highest temperature T load is set at the lowest temperature

MO-P steel bonded anchor

Intended use
Installation parameters
Curing time

Annex B 4

Table C1: Design method EN 1992-4
Characteristic values of resistance to tension load

Steel failure – Characteristic resistance								
Size			M8	M10	M12	M16	M20	M24
Steel grade 5.8	$N_{Rk,s}$	[kN]	18	29	42	79	123	177
Partial safety factor	γ_{Ms}	[-]	1,5					
Steel grade 8.8	$N_{Rk,s}$	[kN]	29	46	67	126	196	282
Partial safety factor	γ_{Ms}	[-]	1,5					
Steel grade 10.9	$N_{Rk,s}$	[kN]	37	58	84	157	245	353
Partial safety factor	γ_{Ms}	[-]	1,4					
Stainless steel grade A2-70, A4-70	$N_{Rk,s}$	[kN]	26	41	59	110	172	247
Partial safety factor	γ_{Ms}	[-]	1,9					
Stainless steel grade A4-80	$N_{Rk,s}$	[kN]	29	46	67	126	196	282
Partial safety factor	γ_{Ms}	[-]	1,6					
Stainless steel grade 1.4529	$N_{Rk,s}$	[kN]	26	41	59	110	172	247
Partial safety factor	γ_{Ms}	[-]	1,5					

Combined pullout and concrete cone failure in uncracked concrete C20/25								
Size			M8	M10	M12	M16	M20	M24
Characteristic bond resistance in uncracked concrete								
Dry/wet concrete and flooded hole	$\tau_{Rk,ucr}$	[N/mm ²]	9,5	9	8,5	8	7,5	7
Installation safety factor	$\gamma_2^{(1)}=\gamma_{inst}^{(2)}$	[-]	1,2					
Factor for concrete	C30/37	ψ_c	[-]	1,12				
	C35/45			1,19				
	C50/60			1,30				

Concrete cone failure								
Factor for concrete cone failure	$\frac{k_1^{(1)}}{k_{ucr,N}^{(2)}}$	[-]	10,1					
			11					
Edge distance	$C_{cr,N}$	[mm]	1,5h _{ef}					
Installation safety factor	$\gamma_2^{(1)}=\gamma_{inst}^{(2)}$	[-]	1,2					

Splitting failure								
Size			M8	M10	M12	M16	M20	M24
Edge distance	$C_{cr,sp}$	[mm]	2,0h _{ef}			1,5h _{ef}		
Spacing	$S_{cr,sp}$	[mm]	4,0h _{ef}			3,0h _{ef}		
Installation safety factor	$\gamma_2^{(1)}=\gamma_{inst}^{(2)}$	[-]	1,2					

¹⁾ Design according EOTA Technical Report TR 055

²⁾ Design according EN 1992-4:2016

MO-P steel bonded anchor	Annex C 1
Performances Characteristic resistance for tension loads	

Table C2: Design method EN 1992-4
Characteristic values of resistance to shear load

Steel failure without lever arm							
Size		M8	M10	M12	M16	M20	M24
Steel grade 5.8	$V_{Rk,s}$ [kN]	9	15	21	39	61	88
Partial safety factor	γ_{Ms} [-]	1,25					
Steel grade 8.8	$V_{Rk,s}$ [kN]	15	23	34	63	98	141
Partial safety factor	γ_{Ms} [-]	1,25					
Steel grade 10.9	$V_{Rk,s}$ [kN]	18	29	42	79	123	177
Partial safety factor	γ_{Ms} [-]	1,5					
Stainless steel grade A2-70, A4-70	$V_{Rk,s}$ [kN]	13	20	30	55	86	124
Partial safety factor	γ_{Ms} [-]	1,56					
Stainless steel grade A4-80	$V_{Rk,s}$ [kN]	15	23	34	63	98	141
Partial safety factor	γ_{Ms} [-]	1,33					
Stainless steel grade 1.4529	$V_{Rk,s}$ [kN]	13	20	30	55	86	124
Partial safety factor	γ_{Ms} [-]	1,25					
Characteristic resistance of group of fasteners							
Ductility factor $k_7 = 1,0$ for steel with rupture elongation $A_5 > 8\%$							

Steel failure with lever arm							
Size		M8	M10	M12	M16	M20	M24
Steel grade 5.8	$M^o_{Rk,s}$ [N.m]	19	37	66	166	325	561
Partial safety factor	γ_{Ms} [-]	1,25					
Steel grade 8.8	$M^o_{Rk,s}$ [N.m]	30	60	105	266	519	898
Partial safety factor	γ_{Ms} [-]	1,25					
Steel grade 10.9	$M^o_{Rk,s}$ [N.m]	37	75	131	333	649	1123
Partial safety factor	γ_{Ms} [-]	1,50					
Stainless steel grade A2-70, A4-70	$M^o_{Rk,s}$ [N.m]	26	52	92	233	454	786
Partial safety factor	γ_{Ms} [-]	1,56					
Stainless steel grade A4-80	$M^o_{Rk,s}$ [N.m]	30	60	105	266	519	898
Partial safety factor	γ_{Ms} [-]	1,33					
Stainless steel grade 1.4529	$M^o_{Rk,s}$ [N.m]	26	52	92	233	454	786
Partial safety factor	γ_{Ms} [-]	1,25					
Concrete pry-out failure							
Factor for resistance to pry-out failure	k_8 [-]	2					
Installation safety factor	$\gamma_2^{(1)} = \gamma_{inst}^{(2)}$ [-]	1,0					

Concrete edge failure							
Size		M8	M10	M12	M16	M20	M24
Outside diameter of fastener	d_{nom} [mm]	8	10	12	16	20	24
Effective length of fastener	l_f [mm]	min (h_{ef} , $8 d_{nom}$)					
Installation safety factor	$\gamma_2^{(1)} = \gamma_{inst}^{(2)}$ [-]	1,0					

¹⁾ Design according EOTA Technical Report TR 055

²⁾ Design according EN 1992-4:2016

MO-P steel bonded anchor

Performances

Characteristic resistance for shear loads

Annex C 2

Table C3: Displacement under tension and shear load

Anchor size			M8	M10	M12	M16	M20	M24
Tension load	F	[kN]	6,3	9,9	15,9	23,8	29,8	37,7
Displacement	δ_{N0}	[mm]	0,1	0,2	0,3	0,5	0,7	0,9
	$\delta_{N\infty}$	[mm]	0,4	0,4	0,4	0,4	0,4	0,4
Shear load	F	[kN]	5,2	8,3	12,0	22,4	35,0	50,4
Displacement	δ_{V0}	[mm]	0,1	0,1	0,2	0,4	0,8	1,5
	$\delta_{V\infty}$	[mm]	0,2	0,2	0,3	0,6	1,2	2,3

MO-P steel bonded anchor**Performances**
Displacement**Annex C 3**