

MO-P+



CHARACTERISTICS

- Assessed for all types of concrete, non-cracked, and all concrete applications. Valid for hollow and solid masonry.
- Assessed studs from M8 to M24.
- Use for medium-high loads.
- Valid for dry, wet and flooded holes.
- Use for static or quasi-static loads.
- Versions in zinc plated steel and stainless steel A2 and A4.
- Temperature range: from -40°C to +80°C (long term maximum temperature +50°C).

CERTIFICATES



APPLICATIONS

- Use in indoor and outdoor environments.
- Structural applications.
- For fixing stone cladding.
- Rehabilitation of facades.
- For fixing notices, air conditioning supports, boilers, awnings, signs, balconies, shelving units, railings, etc.

BASE MATERIAL

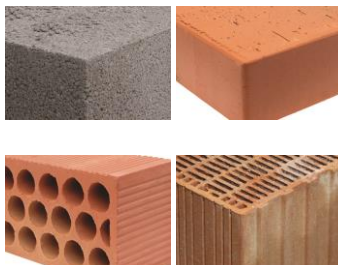

MAXIMUM LOAD RECOMMENDED [kg]

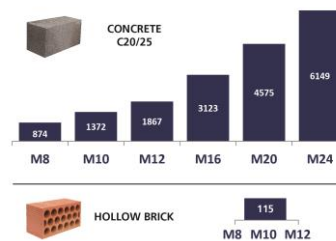

DRILL HOLE CONDITION

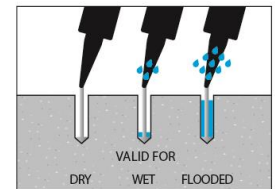

APPLICATION EXAMPLES



VALID FOR

STUD









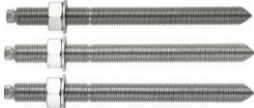

M8-M24 Stud

1. RANGE



ITEM	CODE	SIZE	PHOTO	COMOPONENT	MATERIAL	
1	MOP300 MOP410	300 ml. 410 ml.		POLYESTER MORTAR	Polyester resin. Format: cartridges of 300 and 410 ml	12

2. ACCESSORIES



ITEM	CODE	PHOTO	COMPONENT	MATERIAL
1	MOPISSI		APPLICATION GUNS	Gun for 300 ml standard cartridges
	MOPISTO			Gun for 410 ml coaxial cartridges
2	EQ-AC EQ-A2 EQ-A4		STUD BOLTS	Threaded steel stud, class 5.8 ISO 898-1 Threaded stainless steel stud A2-70 Threaded stainless steel stud A4-70
3	MORCEPKIT		CLEANING BRUSHES	3 Cleaning brushes kit of $\varnothing 14$, $\varnothing 20$ and $\varnothing 29$ mm.
4	MOBOMBA		CLEANING PUMP	Pump for cleaning dust and drill hole fragments
5	MORCANU		MIXING NOZZLE	Plastic. Helix static mixer.
6	MO-TN		NYLON SLEEVE	Plastic. Available in white and grey
7	MO-TR		METAL THREADED SLEEVE	Metal threaded sleeve M8, M10, M12, zinc plated.
8	MO-TM		METAL SLEEVE	Metal sleeve of $\varnothing 12$, $\varnothing 16$ and $\varnothing 22$,

3. INSTALLATION DATA

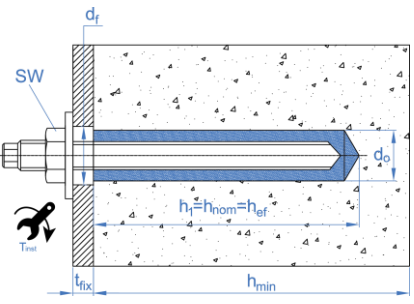
3.1. CONCRETE FIXING (SET UP PARAMETERS)

SIZE		M8	M10	M12	M16	M20	M24
d_0 : nominal diameter	[mm]	10	12	14	18	22	26
d_f : fixture hole diameter \leq	[mm]	9	12	14	18	22	26
T_{ins} : torque \leq	[Nm]	10	20	40	80	150	200
Circular cleaning brush diameter		$\varnothing 14$		$\varnothing 20$		$\varnothing 29$	
$h_{ef,min} = 8d$							
h_1 : drill hole depth	[mm]	64	80	96	128	160	192
$s_{cr,N}$: critical spacing	[mm]	192	240	288	384	480	576
$c_{cr,N}$: critical edge distance	[mm]	96	120	144	192	240	288
c_{min} : minimum distance to edge	[mm]	35	40	50	65	80	96
s_{min} : minimum spacing	[mm]	35	40	50	65	80	96
h_{min} : minimum concrete thickness	[mm]	100	110	126	158	204	244
Standard stud							
h_1 : drill hole depth	[mm]	80	90	110	128	170	210
$s_{cr,N}$: critical spacing	[mm]	240	270	330	384	510	630
$c_{cr,N}$: critical edge distance	[mm]	120	135	165	192	255	315
c_{min} : minimum distance to edge	[mm]	43	45	56	65	85	105
s_{min} : minimum spacing	[mm]	43	45	56	65	85	105
h_{min} : minimum concrete thickness	[mm]	110	120	140	158	214	262
$h_{ef,max} = 12d$							
h_1 : drill hole depth	[mm]	96	120	144	192	240	288
$s_{cr,N}$: critical spacing	[mm]	288	360	432	576	720	864
$c_{cr,N}$: critical edge distance	[mm]	144	180	216	288	360	432
c_{min} : minimum distance to edge	[mm]	50	60	70	95	120	145
s_{min} : minimum spacing	[mm]	50	60	70	95	120	145
h_{min} : minimum concrete thickness	[mm]	126	150	174	222	284	340
Zinc plated stud code 		EQAC08110	EQAC10130	EQAC12160	EQAC16190	EQAC20260	EQAC24300
Stainless steel stud code A2 / A4 		EQA208110 EQA408110	EQA210130 EQA410130	EQA212160 EQA412160	EQA216190 EQA416190	EQA220260 EQA420260	EQA224300 EQA424300
		<ul style="list-style-type: none"> h_{ef} depth value may be selected by the user ranging between $h_{ef,min} = 8d$ and $h_{ef,max} = 12d$. Any intermediate values may be interpolated. Critical distances are those where anchors in a group of anchors are not influenced by one another with regard to tension load effects. For smaller distances, down to minimum distances, corresponding reduction coefficients must be applied. Standard studs are available for each measurement, as shown in the table. 					

3.2. FIXING IN SOLID OR HOLLOW MASONRY (SET UP PARAMETERS)

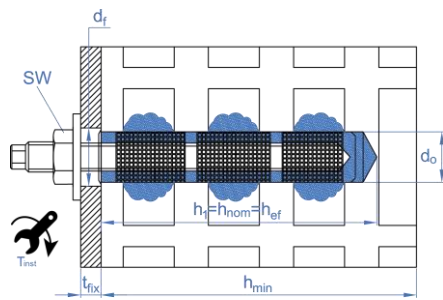

SIZE		M8	M10	M12
Nylon Sleeve	ls		85	
	d _o	15	15	20
Mortar volume per sleeve	[ml]	15	15	27
h ₁ : drill hole depth ≥	[mm]		90	
h _{nom} : sleeve installation depth	[mm]		85	
h _{ef} : stud bolt depth ≥	[mm]		80	
t _{fix} : thickness of material to be fixed ≤	[mm]	22	25	18
h _c : base material thickness ≥	[mm]		110	
d _f : metal sheet diameter ≤	[mm]	9	12	14
T _{ins} : torque ≤	[Nm]		2	
Circular brush	[mm]		ø20	
Stud code		MOES08110	MOES10115	MOES12110
Sleeve code		MOTN15085	MOTN15085	MOTN20085

BASE MATERIAL		NYLON SLEEVE								
		M8			M10			M12		
Critical/Minimum spacing and distance to edge		C _{cr} = C _{min}	S _{cr II} = S _{min II}	S _{min ±} = C _{min ±}	C _{cr} = C _{min}	S _{cr II} = S _{min II}	S _{min ±} = C _{min ±}	C _{cr} = C _{min}	S _{cr II} = S _{min II}	S _{min ±} = C _{min ±}
Brick number 1	[mm]	100	235	115	100	235	115	120	235	115
Brick number 2	[mm]	100	240	113	100	240	113	120	240	113
Brick number 3	[mm]	100	237	237	100	237	237	120	250	237
Brick number 4	[mm]	128	255	255	128	255	255	128	255	255
Brick number 5	[mm]	128	255	255	128	255	255	128	255	255
Brick number 6	[mm]	100	250	240	100	250	240	120	250	240
Brick number 7	[mm]	100	250	248	100	250	248	--	--	--
Brick number 8	[mm]	100	250	248	100	250	248	120	250	248
Brick number 9	[mm]	100	370	238	100	370	238	120	370	238



In order to make fixations in hollow bricks a nylon sleeve should be used to prevent the resin from falling through the inner holes.

In some cases to perform installations in bricks where a stud is required to be threaded, a metal sleeve with an internal thread can be used for fixing. In this case, the metal sleeve with internal thread must be inside a plastic sleeve. The parameters are indicated in the following table:

SIZE		M8	M10	M12						
Metal threaded sleeve (d ₀ x l _t)	[mm]	12X80	14X80	16X80						
Nylon Sleeve	l _s		85							
	d ₀	15	20	20						
Mortar volume per sleeve	[ml]	15	15	20						
h ₁ : drill hole depth ≥	[mm]		90							
h _{nom} : sleeve installation depth	[mm]		85							
h _{ef} : metal threaded sleeve depth ≥	[mm]		80							
t _{fix} : thickness of material to be fixed ≤	[mm]	26	32	24						
h _c : base material thickness ≥	[mm]		110							
d _f : metal sheet diameter ≤	[mm]	9	12	14						
T _{ins} : torque ≤	[Nm]		2							
Circular brush	[mm]		ø20							
Stud code		MOES08110	MOES10115	MOES12110						
Sleeve code		MOTN15085	MOTN15085	MOTN20085						
Metal sleeve code		MOTRO08	MOTRO10	MOTRO12						
BASE MATERIAL	METAL SLEEVE									
	M8			M10			M12			
Critical/Minimum spacing and distance to edge		C _{cr} = C _{min}	S _{cr II} = S _{min II}	S _{min ⊥} = C _{min ⊥}	C _{cr} = C _{min}	S _{cr II} = S _{min II}	S _{min ⊥} = C _{min ⊥}	C _{cr} = C _{min}	S _{cr II} = S _{min II}	S _{min ⊥} = C _{min ⊥}
Brick number 1	[mm]	100	235	115	120	235	115	120	235	115
Brick number 2	[mm]	100	240	113	120	240	113	120	240	113
Brick number 3	[mm]	--	--	--	120	250	237	120	250	237
Brick number 4	[mm]	128	255	255	128	255	255	128	255	255
Brick number 5	[mm]	128	255	255	128	255	255	128	255	255
Brick number 6	[mm]	100	250	240	120	250	240	120	250	240
Brick number 7	[mm]	100	250	248	120	250	248	120	250	248
Brick number 8	[mm]	--	--	--	120	250	248	120	250	248
Brick number 9	[mm]	100	370	238	120	370	238	120	370	238

BRICK TYPES

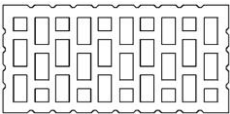
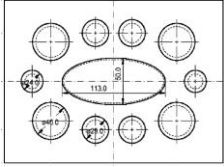
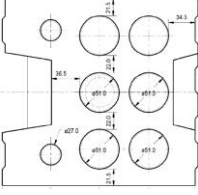
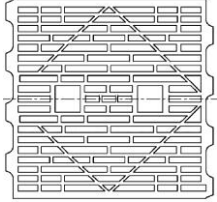
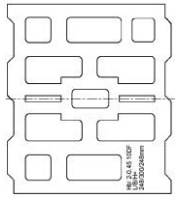
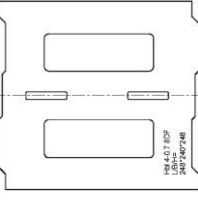
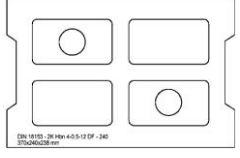
<p>Brick nº 1 Hollow baked clay brick HLz 12-1, 0-2DF according to EN 771-1 Length / width / height: 235 mm / 112 mm / 115 mm $f_b \geq 12 \text{ N/mm}^2 / \rho \geq 1,0 \text{ kg/dm}^3$</p>		<p>Brick nº 2 Hollow sillico calcareous brick KSL 12-1, 4-3DF according to EN 771-2 Length / width / height: 240 mm / 175 mm / 113 mm $f_b \geq 12 \text{ N/mm}^2 / \rho \geq 1,4 \text{ kg/dm}^3$</p>	
<p>Brick nº 3 Hollow sillico calcareous brick KSL 12-1, 4-2DF according to EN 771-2 Length / width / height: 250 mm / 240 mm / 237 mm $f_b \geq 12 \text{ N/mm}^2 / \rho \geq 1,4 \text{ kg/dm}^3$</p>		<p>Brick nº 4 Solid baked clay brick Mz 12-2, 0-NF according to EN 771-1. Length / width / height: 240 mm / 116 mm / 71 mm $f_b \geq 12 \text{ N/mm}^2 / \rho \geq 2,0 \text{ kg/dm}^3$</p>	<p>Brick nº 5 Solid sillico calcareous brick KS 12-2, 0-NF according to EN 771-2. Length / width / height: 240 mm / 115 mm / 70 mm $f_b \geq 12 \text{ N/mm}^2 / \rho \geq 2,0 \text{ kg/dm}^3$</p>
<p>Brick nº 6 Hollow baked clay brick HLzW 6-0,7-8DF according to EN 771-1 Length / width / height: 250 mm / 240 mm / 240 mm $f_b \geq 6 \text{ N/mm}^2 / \rho \geq 0,8 \text{ kg/dm}^3$</p>		<p>Brick nº 7 Hollow lightweight concrete block Hbl 2-0,45-10DF according to EN 771-3 Length / width / height: 250 mm / 300 mm / 248 mm $f_b \geq 2,0 \text{ N/mm}^2 / \rho \geq 0,45 \text{ kg/dm}^3$</p>	
<p>Brick nº 8 Hollow lightweight concrete block Hbl 4-0, 7-8DF according to EN 771-3 Length / width / height: 250 mm / 240 mm / 248 mm $f_b \geq 4,0 \text{ N/mm}^2 / \rho \geq 0,7 \text{ kg/dm}^3$</p>		<p>Brick nº 9 Concrete block Hbn 4-12DF according to EN 771-3 Length / width / height: 370 mm / 240 mm / 238 mm $f_b \geq 4 \text{ N/mm}^2 / \rho \geq 1,2 \text{ kg/dm}^3$</p>	

4. PRODUCT SET UP

4.1. CONCRETE SET UP

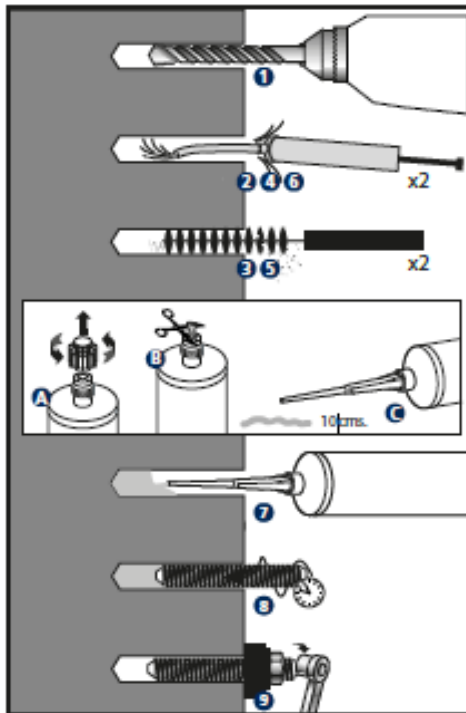

1. DRILL

Check the concrete base is compact and porosity is insignificant.
 Suitable for wet, dry or flooded drill holes.
 Cartridge installation temperature: $\geq 5\text{ }^{\circ}\text{C}$.
 Base material installation temperature: MO-P+ $\geq -5\text{ }^{\circ}\text{C}$
 Use drill in hammer mode.
 Drill to the specified diameter and depth values

2 - 6. BLOW AND CLEAN

Clear the drill holes completely of dust and fragments by following the procedure shown in the picture. If the drill hole is flooded, the water must be removed before mortar is injected.

A - B* - C. OPEN CARTRIDGE

Screw the nozzle into the cartridge and place the assembly in the application gun. Squeeze on the trigger repeatedly until the mortar comes out of the nozzle in a uniform grey color. Any iridescence indicates improper mixing. Always discard the first two doses of each cartridge: these are never to be used for fixing. ***For 300 ml cartridges, cut end of bag, behind seal clip.**

7. INJECT MORTAR

Insert the nozzle to the bottom of the drill hole and apply mortar: gradually remove the nozzle, ensuring there are no air bubbles. Fill the hole to $\frac{1}{2}$ and $\frac{3}{4}$ of its depth.
 In the event of not fully using the cartridge, leave nozzle attached. Only change if using again and handling time has expired, remembering to discard the first two doses of mortar.

8. INSTALLATION

Introduce the stud to be installed by screwing it lightly down to the installation depth value manually; ensuring the mortar covers the stud thread. The introduction of the anchor must take place within the handling time. The mortar must seep from the top of the drill hole to ensure it is completely full and there are no gaps between the stud and the drill hole.

TEMPERATURE AND CURING TIME

TYPE	Base material temperature [$^{\circ}\text{C}$]	Handling time [min]	Curing time [min]
MO-P	-5 a 0*	28	360
	0 a +5*	18	145
	+5 to +10	10	145
	+10 to +20	6	85
	+20 to +25	5	50
	+25 to +30	4	40
	+30	4	35

*Installation temperature not covered by the ETA.

9. APPLY TORQUE

Once the curing time has elapsed, apply torque, never exceeding the values indicated in the table.

4.2. MASONRY SET UP

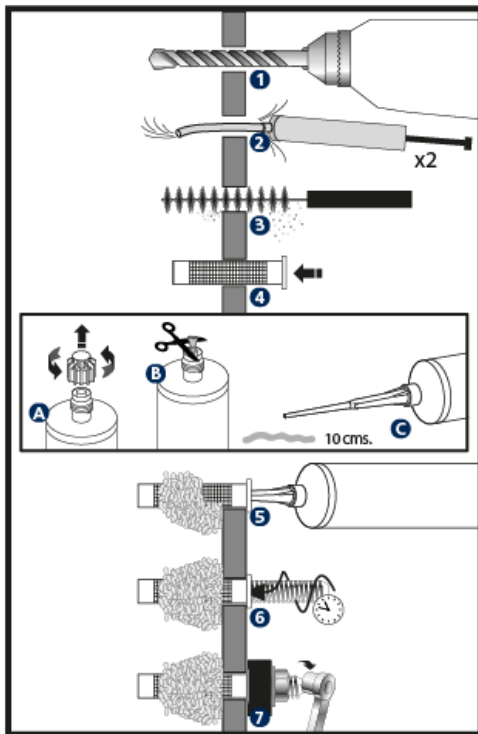

1. DRILL

Check the concrete base is compact and porosity is insignificant.
 Suitable for wet, dry or flooded drill holes.
 Cartridge installation temperature: $\geq 5\text{ }^{\circ}\text{C}$.
 Base material installation temperature: MO-P+ $\geq -5\text{ }^{\circ}\text{C}$
 Use drill in rotation mode.
 Drill to the specified diameter and depth values

2 - 3. BLOW AND CLEAN

Clear the drill holes completely of dust and fragments by following the procedure shown in the picture. If the drill hole is flooded, the water must be removed before mortar is injected.

4. POSITION SLEEVE(s)

Insert the metal or plastic sleeve into the drill hole so it is level with the surface of the base material.

A – B* – C. OPEN CARTRIDGE

Screw the nozzle into the cartridge and place the assembly in the application gun. Squeeze on the trigger repeatedly until the mortar comes out of the nozzle in a uniform grey color. Any iridescence indicates improper mixing. Always discard the first two doses of each cartridge: these are never to be used for fixing. *For 300 ml cartridges, cut end of bag, behind seal clip.

5. INJECT MORTAR

Insert the nozzle to the bottom of the drill hole and apply mortar: gradually remove the nozzle, ensuring there are no air bubbles. Fill the sleeve fully.
 In the event of not fully using the cartridge, leave nozzle attached. Only change if using again and handling time has expired, remembering to discard the first two doses of mortar.

6. INSTALLATION

Introduce the stud to be installed by screwing it lightly down to the installation depth value manually; ensuring the mortar covers the stud thread. The introduction of the anchor must take place within the handling time. The mortar must seep from the top of the sleeve hole to ensure it is completely full and there are no gaps between the stud and the drill hole.

TEMPERATURE AND CURING TIME

TYPE	Base material temperature [°C]	Handling time [min]	Curing time [min]
MO-P	-5 a 0*	28	360
	0 a +5*	18	145
	+5 a +10	10	145
	+10 a +20	6	85
	+20 a +25	5	50
	+25 a +30	4	40
	+30	4	35

*Installation temperature not covered by the ETA.

7. APPLY TORQUE

Once the curing time has elapsed, apply torque, never exceeding the values indicated in the table.

5. STORAGE CONDITIONS

Keep the product stored in a cool, dry place, away from direct sunlight and heat sources, at an average temperature between +5 °C and +25 °C.

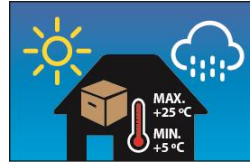
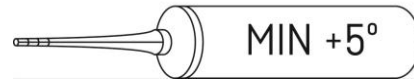

Shelf life of unopened cartridge: 18 months from the date of manufacture. The expiration date is indicated on the cartridge.

6. RESISTANCES

6.1 CONCRETE FIXATION

Characteristic resistances for C20/25 concrete for an isolated anchor (without considering anchor-to-anchor or anchor-to-edge distance effects) and class 5.8 studs or A4-70 stainless steel are shown in tables below.

CHARACTERISTIC RESISTANCES

CONCRETE CLASS	SIZE				M8	M10	M12	M16	M20	M24		
NON-CRACKED CONCRETE	ZINC PLATED	Tension	$h_{ef,min} = 8d$	N_{Rk}	[kN]	15,2	22,6	30,8	51,5	75,4	101,3	
			Standard stud	N_{Rk}	[kN]	19,1	25,4	35,2	51,5	80,1	110,8	
			$h_{ef,max} = 12d$	N_{Rk}	[kN]	<u>18</u>	33,9	46,1	77,2	113,1	152,0	
	STAINLESS STEEL	Tension	All depths		V_{Rk}	[kN]	<u>9,0</u>	<u>15,0</u>	<u>21,0</u>	<u>39,0</u>	<u>61,0</u>	<u>88,0</u>
				$h_{ef,min} = 8d$	N_{Rk}	[kN]	15,2	22,6	30,8	51,5	75,4	101,3
				Standard stud	N_{Rk}	[kN]	19,1	25,4	35,2	51,5	80,1	110,8
		Shear	All depths		N_{Rk}	[kN]	22,9	33,9	46,1	77,2	113,1	152,0
				$h_{ef,max} = 12d$	N_{Rk}	[kN]	22,9	33,9	46,1	77,2	113,1	152,0
					V_{Rk}	[kN]	<u>13,0</u>	<u>20,0</u>	<u>30,0</u>	<u>55,0</u>	<u>86,0</u>	<u>124,0</u>

DESIGN RESISTANCES

CONCRETE CLASS	SIZE				M8	M10	M12	M16	M20	M24			
	NON-CRACKED CONCRETE	ZINC PLATED	Tension	$h_{ef,min} = 8d$	N_{Rd}	[kN]	8,4	12,5	17,0	28,6	41,8	56,3	
Standard stud				N_{Rd}	[kN]	10,6	14,1	19,5	28,6	44,5	61,5		
$h_{ef,max} = 12d$				N_{Rd}	[kN]	<u>12,0</u>	18,8	25,6	42,8	62,8	84,4		
STAINLESS STEEL		Tension	$h_{ef,min} = 8d$	N_{Rd}	[kN]	8,4	12,5	17,0	28,6	41,8	56,3		
			Standard stud	N_{Rd}	[kN]	10,6	14,1	19,5	28,6	44,5	61,5		
			$h_{ef,max} = 12d$	N_{Rd}	[kN]	12,7	18,8	25,6	42,8	62,8	84,4		
STAINLESS STEEL		Shear	All depths	V_{Rd}	[kN]	<u>7,2</u>	<u>12,0</u>	<u>16,8</u>	<u>31,2</u>	<u>48,8</u>	<u>70,4</u>		
			STAINLESS STEEL	Tension	$h_{ef,min} = 8d$	N_{Rd}	[kN]	8,4	12,5	17,0	28,6	41,8	56,3
					Standard stud	N_{Rd}	[kN]	10,6	14,1	19,5	28,6	44,5	61,5
$h_{ef,max} = 12d$		N_{Rd}			[kN]	12,7	18,8	25,6	42,8	62,8	84,4		
STAINLESS STEEL	Shear	All depths	V_{Rd}	[kN]	<u>8,3</u>	<u>12,8</u>	<u>19,2</u>	<u>35,2</u>	<u>55,1</u>	<u>79,4</u>			

MAXIMUM LOADS RECOMMENDED (when $\gamma_F = 1.4$)

CONCRETE CLASS	SIZE				M8	M10	M12	M16	M20	M24	
	NON-CRACKED CONCRETE	ZINC PLATED	Tension	$h_{ef,min} = 8d$	N_{rec}	[kN]	6,0	8,9	12,2	20,4	29,9
Standard stud				N_{rec}	[kN]	7,5	10,1	13,9	20,4	31,7	43,9
$h_{ef,max} = 12d$				N_{rec}	[kN]	<u>8,5</u>	13,4	18,3	30,6	44,8	60,3
STAINLESS STEEL		Tension	$h_{ef,min} = 8d$	N_{rec}	[kN]	6,0	8,9	12,2	20,4	29,9	40,2
			Standard stud	N_{rec}	[kN]	7,5	10,1	13,9	20,4	31,7	43,9
			$h_{ef,max} = 12d$	N_{rec}	[kN]	9,1	13,4	18,3	30,6	44,8	60,3
STAINLESS STEEL		Shear	All depths	V_{rec}	[kN]	<u>5,9</u>	<u>9,1</u>	<u>13,7</u>	<u>25,1</u>	<u>39,3</u>	<u>56,7</u>

1 kN \approx 100 kg

The italic font underlined values indicate steel failure; rest indicates pull-out failure.

**COEFFICIENTS FOR TENSION LOADS
IN PULL-OUT FAILURE IN HIGH-RESISTANCE CONCRETE TYPES**

CONCRETE COEFFICIENT	C30/37	C40/50	C50/60
Ψ_c (Non-cracked)	1,12	1,19	1,30

6.2 MASONRY FIXATION

Characteristic resistances in masonry for an isolated anchor (without considering anchor-to-anchor or anchor-to-edge distance effects) and class 5.8 studs or A4-70 stainless steel are shown in tables below.

CHARACTERISTIC RESISTANCES (F_{Rk})

BASE MATERIAL	THREADED RODS TENSION AND SHEAR [kN]			THREADED METAL SLEEVE TENSION AND SHEAR [kN]		
	M8	M10	M12	M8	M10	M12
BRICK NUMBER 1	2,5	2	2	1,5	2,5	2,5
BRICK NUMBER 2	0,75	1,2	0,5	0,6	0,75	0,9
BRICK NUMBER 3	0,75	1,2	0,5	--	0,75	0,4
BRICK NUMBER 4	1,5	1,5	3	2	3	4
BRICK NUMBER 5	0,75	0,9	1,5	2	1,5	0,9
BRICK NUMBER 6	1,2	1,2	0,9	0,9	1,5	0,6
BRICK NUMBER 7	0,6	0,2	--	0,5	0,3	0,75
BRICK NUMBER 8	0,6	1,5	1,2	--	0,4	0,6
BRICK NUMBER 9	2,5	1,5	2,5	0,6	1,2	0,9

DESIGN RESISTANCES (F_{Rd})

BASE MATERIAL	THREADED RODS TENSION AND SHEAR [kN]			THREADED METAL SLEEVE TENSION AND SHEAR [kN]		
	M8	M10	M12	M8	M10	M12
BRICK NUMBER 1	1	0,8	0,8	0,6	1	1
BRICK NUMBER 2	0,3	0,48	0,2	0,24	0,3	0,36
BRICK NUMBER 3	0,3	0,48	0,2	--	0,3	0,16
BRICK NUMBER 4	0,6	0,6	1,2	0,8	1,2	1,6
BRICK NUMBER 5	0,3	0,36	0,6	0,8	0,6	0,36
BRICK NUMBER 6	0,48	0,48	0,36	0,36	0,6	0,24
BRICK NUMBER 7	0,24	0,08	--	0,2	0,12	0,3
BRICK NUMBER 8	0,24	0,6	0,48	--	0,16	0,24
BRICK NUMBER 9	1	0,6	1	0,24	0,48	0,36

MAXIMUM LOADS RECOMMENDED (F_{recom}) [with $\gamma_F= 1.4$]

BASE MATERIAL	THREADED RODS TENSION AND SHEAR [kN]			THREADED METAL SLEEVE TENSION AND SHEAR [kN]		
	M8	M10	M12	M8	M10	M12
BRICK NUMBER 1	0,71	0,57	0,57	0,43	0,71	0,71
BRICK NUMBER 2	0,21	0,34	0,14	0,17	0,21	0,26
BRICK NUMBER 3	0,21	0,34	0,14	--	0,21	0,11
BRICK NUMBER 4	0,43	0,43	0,86	0,57	0,86	1,14
BRICK NUMBER 5	0,21	0,26	0,43	0,57	0,43	0,26
BRICK NUMBER 6	0,34	0,34	0,26	0,26	0,43	0,17
BRICK NUMBER 7	0,17	0,06	--	0,14	0,09	0,21
BRICK NUMBER 8	0,17	0,43	0,34	--	0,11	0,17
BRICK NUMBER 9	0,71	0,43	0,71	0,17	0,34	0,26

6.3 CHEMICAL RESISTANCE

Chemical resistance of the product for different kind of chemical environments and for a specific concentration.

Chemical Environment	Concentration	Result	Chemical Environment	Concentration	Result
Aqueous Solution Acetic Acid	10%	✓	Hexane	100%	C
Acetone	100%	X	Hydrochloric Acid	10%	✓
Aqueous Solution Aluminium Chloride	Saturated	✓		15%	✓
Aqueous Solution Aluminium Nitrate	10%	✓		25%	C
Ammonia Solution	5%	X	Hydrogen Sulphide Gas	100%	✓
Jet Fuel	100%	X	Isoproyl Alcohol	100%	X
Benzene	100%	X	Linseed Oil	100%	✓
Benzoic Acid	Saturated	✓	Lubricating Oil	100%	✓
Benzyl Alcohol	100%	X	Mineral Oil	100%	✓
Sodium Hypochlorite Solution	5 - 15%	✓	Paraffin / Kerosene (Domestic)	100%	C
Butyl Alcohol	100%	C	Phenol Aqueous Solution	1%	X
Calcium Sulphate Aqueous Solution	Saturated	✓	Phosphoric Acid	50%	✓
Carbon Monoxide	Gas	✓	Potassium Hydroxide	10% / pH13	C
Carbon Tetrachloride	100%	X	Sea Water	100%	C
Chlorine Water	Saturated	X	Styrene	100%	X
Chloro Benzene	100%	X	Sulphur Dioxide Solution	10%	✓
Citric Acid Aqueous Solution	Saturated	✓	Sulphur Dioxide (40°C)	5%	✓
Cyclohexanol	100%	✓	Sulphuric Acid	10%	✓
Diesel Fuel	100%	C		50%	✓
Diethylene Glycol	100%	✓	Turpentine	100%	C
Ethanol	95%	X	White Spirit	100%	✓
Ethanol Aqueous Solution	20%	C	Xylene	100%	X
Heptane	100%	C	Contact only to a maximum of 25°C.		C
Resistant to 75°C with at least 80% of physical properties retained.		✓	Not Resistant		X

7. OFFICIAL DOCUMENTATION

The following documents are available through our Sales Department or on our official website: www.indexfix.com:

- MOPY Safety Data Sheet.
- European Technical Assessment ETA 13/0752 for use on non-cracked concrete according to EAD 330499-00-0601 guide, option 7, for M8 to M24.
- Classified A+ according to French Regulation DEVL11044875A relative to the emission of volatile pollutants for indoor use.
- LEED MOP Sustainability certificate
- Certification AVCP 1020-CPR-090-041426 for use in concrete.
- Declaration of Performance DoP MOP
- INDEXcal anchor calculation software.
- INDEXmor cartridge calculation needs software.