



Epoxy vinyl ester styrene-free mortar anchor, for use in cracked, non-cracked concrete and masonry

MO-H

ETA assessed Option 1 [cracked and non-cracked concrete].



PRODUCT INFORMATION

DESCRIPTION

Epoxy vinyl ester styrene-free chemical anchor. 

OFFICIAL DOCUMENTATION

- ETA 14/0138 option 1, M8 to M30 for non-cracked concrete and M10 to M24 for cracked concrete.
- ETA 13/0780 for post-installed rebar installation.
- ETA 16/0814 for installation in masonry.
- Declaration features DoP MO-H.
- Certificate EVCP 1020-CPR-090-032411 for use in concrete.
- Certificate EVCP 1020-CPD-090-030058 for post-installed rebars.
- Certificate EVCP 1020-CPR-090-036865 for use in masonry.

VALID FOR



Stud



Rebar



Post-installed rebar

DIMENSIONS

Stud M8 - M30

Rebar as stud Ø8 - Ø32

Post-installed rebars Ø8 - Ø25

RANGE OF CALCULATION LOADS

From 11.1 to 69.1 kN [non-cracked].

From 7.0 to 35.1 kN [cracked].

BASE MATERIAL

Concrete quality C20/25 to C50/60 cracked, non-cracked and masonry.



Concrete

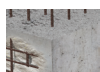

Reinforced concrete



Cracked concrete



Thermal clay



Hollow brick

ASSESSMENTS

- ETA 14/0138 [ETAG 001-5] "Option 1: Cracked and non-cracked concrete."
- ETA 16/0841 [ETAG 029] "Masonry."
- ETA 13/0780 [TR 023] "Post-installed rebars."

DRILL HOLE CONDITION



Dry



Wet



Flooded

CHARACTERISTICS AND BENEFITS

- Use in cracked and non-cracked concrete.
- Used for high loads.
- Temperature range -40°C to +80°C (maximum long-term temperature +50°C).
- Two versions, standard and low temperatures.
- Variety of lengths and diameters: M8-M30-assessed studs, including M27. Use of rebars as anchor from Ø8 to Ø32, assembly flexibility.
- For static or quasi-static loads and category C1 seismic applications.
- Approved for use in contact with drinking water.
- Fire resistance certificate for studs.
- Version in zinc plated steel, stainless steel A2 and A4.
- Available in INDEXcal.



MATERIALS

Standard stud:

Carbon steel, zinc plated $\geq 5 \mu\text{m}$.

Stainless standard stud:

Stainless steel A2-70 and A4-70.





APPLICATIONS

- For indoor and outdoor use.
- Structural applications.
- Substructure fixing to the building.
- Rebars and start rebars.
- For fixing machinery, balconies, awnings, shelving units, billboards, catenaries, safety barriers, railings, handrails, etc.
- Large metric sizes, retaining walls.





CONCRETE INSTALLATION PARAMETERS

METRIC			M8	M10	M12	M16	M20	M24	M27	M30
d_0	nominal diameter	[mm]	10	12	14	18	22	26	30	35
d_f	diameter in anchor plate \leq	[mm]	9	12	14	18	22	26	30	33
T_{inst}	tightening torque \leq	[Nm]	10	20	40	80	150	200	240	275
Circular cleaning brush			$\varnothing 14$		$\varnothing 20$		$\varnothing 29$		$\varnothing 40$	
$h_{ef,min} = 8d$										
h_1	depth of the drill hole	[mm]	64	80	96	128	160	192	216	240
$s_{cr,N}$	critical distance between anchors	[mm]	192	240	288	384	480	576	648	720
$c_{cr,N}$	critical distance from the edge	[mm]	96	120	144	192	240	288	324	360
c_{min}	minimum distance from the edge	[mm]	35	40	50	65	80	96	110	120
s_{min}	minimum distance between anchors	[mm]	35	40	50	65	80	96	110	120
h_{min}	minimum concrete thickness	[mm]	100	110	126	158	204	244	276	310
Standard stud										
h_1	depth of the drill hole	[mm]	80	90	110	128	170	210	-	280
$s_{cr,N}$	critical distance between anchors	[mm]	240	270	330	384	510	630	-	840
$c_{cr,N}$	critical distance from the edge	[mm]	120	135	165	192	255	315	-	420
c_{min}	minimum distance from the edge	[mm]	43	45	56	65	85	105	-	140
s_{min}	minimum distance between anchors	[mm]	43	45	56	65	85	105	-	140
h_{min}	minimum concrete thickness	[mm]	110	120	140	158	214	262	-	350
$h_{ef,max} = 20d$										
h_1	depth of the drill hole	[mm]	160	200	240	320	400	480	540	600
$s_{cr,N}$	critical distance between anchors	[mm]	480	600	720	960	1200	1440	1620	1800
$c_{cr,N}$	critical distance from the edge	[mm]	240	300	360	480	600	720	810	900
c_{min}	minimum distance from the edge	[mm]	80	100	120	160	200	240	270	300
s_{min}	minimum distance between anchors	[mm]	80	100	120	160	200	240	270	300
h_{min}	minimum concrete thickness	[mm]	176	220	264	352	444	532	600	730
Zinc-plated stud code										
			EQAC08110	EQAC10130	EQAC12160	EQAC16190	EQAC20260	EQAC24300	-	EQAC30330
Stainless steel stud code A2 / A4										
			EQA208110 EQA408110	EQA210130 EQA410130	EQA212160 EQA412160	EQA216190 EQA416190	EQA220260 EQA420260	EQA224300 EQA424300	-	EQA230330 EQA430330

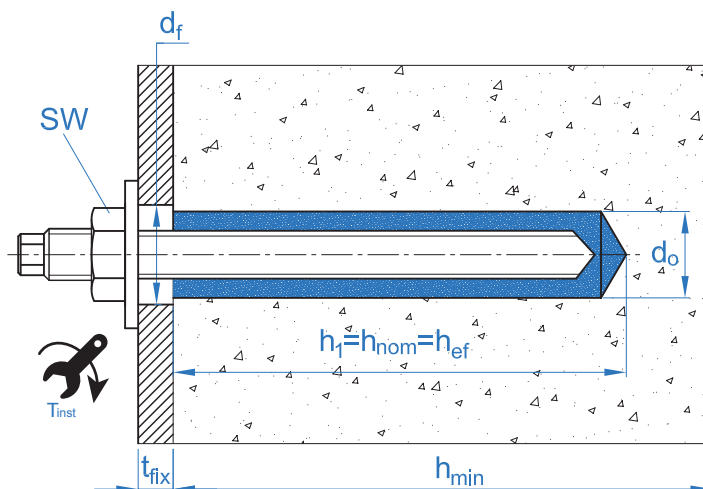



INSTALLATION ACCESSORIES			INSTALLATION PROCEDURE
CODE	PRODUCT	MATERIAL	CONCRETE
MOPISSI	APPLICATION GUNS	Gun for 300 ml cartridges	
MOPISTO		Guns for 410 ml cartridges, professional use	
MOPISENEU		Pneumatic gun for 410 ml coaxial cartridges, professional use	
EQ-AC EQ-A2 EQ-A4	STUD	Studs threaded steel, class 5.8 ISO 898-1 Studs stainless steel A2-70 Studs stainless steel A4-70	
MORCEPKIT	CLEANING BRUSHES	Kit with 3 cleaning brushes measuring $\varnothing 14$, $\varnothing 20$ and $\varnothing 29$ mm	
MOBOMBA	CLEANING PUMP	Pump for cleaning leftover dust and fragments in the drill hole	
MORCANU	MIXING TUBE	Plastic. Static labyrinth mixture	

MINIMUM CURING TIME			
TYPE	BASE MATERIAL TEMPERATURE [°C]	HANDLING TIME [min]	CURING TIME [min]
MO-H	+5 to +10	10	145
	+10 to +15	8	85
	+15 to +20	6	75
	+20 to +25	5	50
	+25 to +30	4	40
MO-HW	-10 to -5	50	12 hours
	-5 to 0	15	100
	0 to +5	10	75
	+5 to +20	5	50
	+20	100 seconds	20



Resistance in concrete C20/25 for an insulated anchor, without effects of distance from the edge or spacing between anchors, with a standard stud EQ-AC, EQ-A2 or EQ-A4.

Characteristic tensile strength N_{Rk}										
Metric		M8	M10	M12	M16	M20	M24	M27	M30	
N_{Rk}	Non-cracked concrete	[kN]	20.1	26.9	39.4	57.9	90.8	126.7	-	145.1
	Cracked concrete	[kN]	-	12.7	18.7	29.0	42.7	63.3	-	-
Calculated tensile strength N_{Rd}										
Metric		M8	M10	M12	M16	M20	M24	M27	M30	
N_{Rd}	Non-cracked concrete	[kN]	11.2	14.9	21.9	32.2	50.4	70.4	-	69.1
	Cracked concrete	[kN]	-	7.1	10.4	16.1	23.7	35.2	-	-
Maximum recommended tensile load N_{rec}										
Metric		M8	M10	M12	M16	M20	M24	M27	M30	
N_{rec}	Non-cracked concrete	[kN]	8.0	10.7	15.6	23.0	36.0	50.3	-	49.4
	Cracked concrete	[kN]	-	5.0	7.4	11.5	17.0	25.1	-	-
Characteristic resistance to shear stress V_{Rk}										
Metric		M8	M10	M12	M16	M20	M24	M27	M30	
V_{Rk}	Zinc-plated stud	[kN]	<u>9.0</u>	<u>15.0</u>	<u>21.0</u>	<u>39.0</u>	<u>61.0</u>	<u>88.0</u>	<u>115.0</u>	<u>140.0</u>
	Stainless steel stud (A2/A4)	[kN]	<u>13.0</u>	<u>20.0</u>	<u>30.0</u>	<u>55.0</u>	<u>86.0</u>	<u>124.0</u>	<u>161.0</u>	<u>196.0</u>
Calculated resistance to shearing V_{Rd}										
Metric		M8	M10	M12	M16	M20	M24	M27	M30	
V_{Rd}	Zinc-plated stud	[kN]	<u>7.2</u>	<u>12.0</u>	<u>16.8</u>	<u>31.2</u>	<u>48.8</u>	<u>70.4</u>	<u>92.0</u>	<u>112.0</u>
	Stainless steel stud (A2/A4)	[kN]	<u>8.3</u>	<u>12.8</u>	<u>19.2</u>	<u>35.3</u>	<u>55.1</u>	<u>79.5</u>	<u>103.2</u>	<u>125.6</u>
Maximum recommended load to shear stress V_{rec}										
Metric		M8	M10	M12	M16	M20	M24	M27	M30	
V_{rec}	Zinc-plated stud	[kN]	<u>5.1</u>	<u>8.6</u>	<u>12.0</u>	<u>22.3</u>	<u>34.9</u>	<u>50.3</u>	<u>65.7</u>	<u>80.0</u>
	Stainless steel stud (A2/A4)	[kN]	<u>6.0</u>	<u>9.2</u>	<u>13.7</u>	<u>25.2</u>	<u>39.4</u>	<u>56.8</u>	<u>73.7</u>	<u>89.7</u>
Effective depth of studs EQ-AC / EQ-A2 / EQ-A4										
Metric		M8	M10	M12	M16	M20	M24	M27	M30	
Effective depth		[mm]	80	90	110	128	170	210	-	280

The values underlined and in italics indicate steel failure

Simplified calculation method. European Technical Assessment ETA 14/0138

Simplified version of the calculation method according to ETAG 001, technical report TR029. The resistance is calculated according to the data reflected in ETA assessment 14/0138.

- Influence of concrete resistance.
- Influence of the distance from the edge of the concrete.
- Influence of the spacing between anchors.
- Influence of rebars.
- Influence of the base material thickness.
- Influence of the load application angle.
- Influence of the effective depth.
- Valid for a group of two anchors.
- Valid for dry or wet drill holes.

The calculation method is based on the following simplification:
No different loads act on individual anchors, without eccentricity.



INDEXcal

For a more precise calculation and taking into account more constructive arrangements we recommend the use of our INDEXcal calculation program. It can be downloaded free from our website www.indexfix.com



TENSILE LOADS

- Calculated steel resistance: $N_{Rd,s}$
- Calculated extraction resistance: $N_{Rd,p} = N_{Rd,p}^o \cdot \psi_c \cdot \psi_{hef,p}$
- Calculated concrete cone resistance: $N_{Rd,c} = N_{Rd,c}^o \cdot \psi_b \cdot \psi_{s,N} \cdot \psi_{c,N} \cdot \psi_{re,N} \cdot \psi_{hef,N}$
- Calculated concrete cracking resistance: $N_{Rd,sp} = N_{Rd,c}^o \cdot \psi_b \cdot \psi_{s,sp} \cdot \psi_{c,sp} \cdot \psi_{re,N} \cdot \psi_{h,sp} \cdot \psi_{hef,N}$

MO-H

		Calculated steel resistance								
		$N_{Rd,s}$								
Metric		M8	M10	M12	M16	M20	M24	M27	M30	
$N_{Rd,s}^o$	Steel class 4.6	[kN]	7.5	11.5	17.0	31.5	49.0	70.5	92.0	112.0
	Steel class 5.8	[kN]	12.0	19.3	28.0	52.7	82.0	118.0	153.3	187.3
	Steel class 8.8	[kN]	19.3	30.7	44.7	84.0	130.7	188.0	244.7	299.3
	Steel class 10.9	[kN]	27.8	43.6	63.2	118.0	184.2	265.4	345.1	421.8
	Stainless steel class A2-70, A4-70	[kN]	13.9	21.9	31.6	58.8	92.0	132.1	171.7	210.2

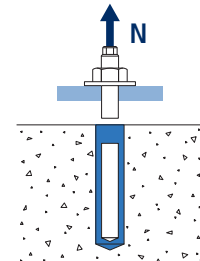

		Calculated extraction resistance								
		$N_{Rd,p} = N_{Rd,p}^o \cdot \psi_c \cdot \psi_{hef,p}$								
Metric		M8	M10	M12	M16	M20	M24	M27	M30	
$N_{Rd,p}^o$	Non-cracked concrete	[kN]	11.2	14.9	21.9	32.2	50.4	70.4	63.8	69.1
	Cracked concrete	[kN]	-	7.1	10.4	16.1	23.7	35.2	-	-

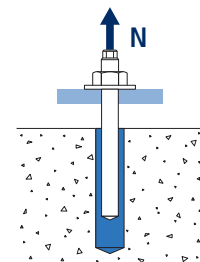

		Calculated concrete cone resistance								
		$N_{Rd,c} = N_{Rd,c}^o \cdot \psi_b \cdot \psi_{s,N} \cdot \psi_{c,N} \cdot \psi_{re,N} \cdot \psi_{hef,N}$								
Metric		M8	M10	M12	M16	M20	M24	M27	M30	
$N_{Rd,c}^o$	Non-cracked concrete	[kN]	20.1	24.0	32.4	40.6	62.2	85.4	91.1	112.7
	Cracked concrete	[kN]	14.3	17.1	23.1	29.0	44.3	60.9	75.8	93.7

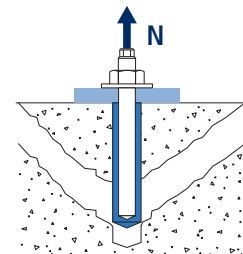

		Calculated concrete cracking resistance								
		$N_{Rd,sp} = N_{Rd,c}^o \cdot \psi_b \cdot \psi_{s,sp} \cdot \psi_{c,sp} \cdot \psi_{re,N} \cdot \psi_{h,sp} \cdot \psi_{hef,N}$								
Metric		M8	M10	M12	M16	M20	M24	M27	M30	
$N_{Rd,sp}^o$	Non-cracked concrete	[kN]	20.1	24.0	32.4	40.6	62.2	85.4	91.1	112.7

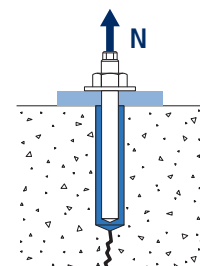



MO-H

Influence coefficients

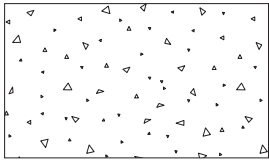

$$\Psi_b = \sqrt{\frac{f_{ck,cube}}{25}} \geq 1$$

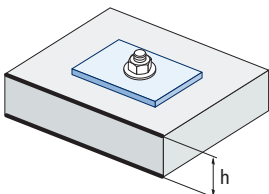
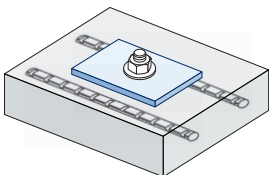
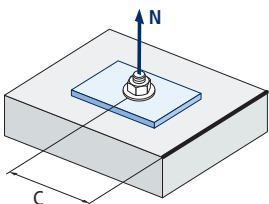
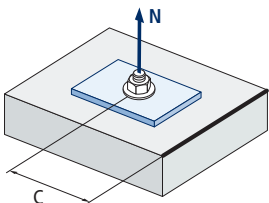
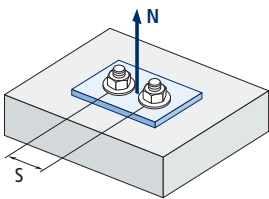
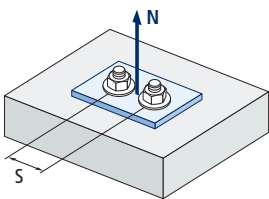

Influence of concrete resistance for extraction Ψ_c					
Concrete type		C20/25	C30/37	C40/50	C50/60
Ψ_c	Non-cracked concrete	1.0			
	Cracked concrete	1.00	1.12	1.23	1.30

Influence of concrete resistance for concrete cone and concrete cracking Ψ_b					
Concrete type		C20/25	C30/37	C40/50	C50/60
Ψ_b		1.00	1.22	1.41	1.55

Influence of spacing between anchors (concrete cone) $\Psi_{s,N}$										
$s/s_{cr,N}$	0.1	0.2	0.3	0.4	0.5	0.6	0.7	0.8	0.9	1.0
$\Psi_{s,N}$	0.55	0.60	0.65	0.70	0.75	0.80	0.85	0.90	0.95	1.00

$$\Psi_{s,N} = 0.5 \left(1 + \frac{s}{s_{cr,N}} \right) \leq 1$$

Influence of spacing between anchors (cracking) $\Psi_{s,sp}$										
$s/s_{cr,sp}$	0.1	0.2	0.3	0.4	0.5	0.6	0.7	0.8	0.9	1.0
$\Psi_{s,sp}$	0.55	0.60	0.65	0.70	0.75	0.80	0.85	0.90	0.95	1.00

$$\Psi_{s,sp} = 0.5 \left(1 + \frac{s}{s_{cr,sp}} \right) \leq 1$$

Influence of the distance from the edge of the concrete (concrete cone) $\Psi_{c,N}$												
$c/C_{cr,N}$	0.1	0.2	0.3	0.5	0.6	0.8	0.9	1.1	1.2	1.4	1.5	1.6
$\Psi_{c,N}$	0.40	0.46	0.51	0.45	0.49	0.55	0.61	0.67	0.75	0.83	0.91	1.00

$$\Psi_{c,N} = 0.35 + \frac{0.5 \cdot c}{C_{cr,N}} + \frac{0.15 \cdot c^2}{C_{cr,N}^2} \leq 1$$

Influence of the distance from the edge of the concrete (cracking) $\Psi_{c,sp}$												
$c/C_{cr,sp}$	0.1	0.2	0.3	0.5	0.6	0.8	0.9	1.1	1.2	1.4	1.5	1.6
$\Psi_{c,sp}$	0.40	0.46	0.51	0.45	0.49	0.55	0.61	0.67	0.75	0.83	0.91	1.00

$$\Psi_{c,sp} = 0.35 + \frac{0.5 \cdot c}{C_{cr,sp}} + \frac{0.15 \cdot c^2}{C_{cr,sp}^2} \leq 1$$

Influence of the rebars $\Psi_{re,N}$					
h_{ef} (mm)	64	70	80	90	100
$\Psi_{re,N}$	0.82	0.85	0.90	0.95	1.00

$$\Psi_{re,N} = 0.5 + \frac{h_{ef}}{200} \leq 1$$

Influence of the base material thickness $\Psi_{h,sp}$											
$\Psi_{h,sp}$	h/h_{ef}	2.00	2.20	2.40	2.60	2.80	3.00	3.20	3.40	3.60	3.68
	fh	1.00	1.07	1.13	1.19	1.25	1.31	1.37	1.42	1.48	1.50

$$\Psi_{h,sp} = \left(\frac{h}{2 \cdot h_{ef}} \right)^{2/3} \leq 1.5$$



MO-H

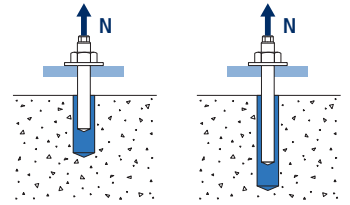

$$\Psi_{\text{hef,p}} = \frac{h_{\text{ef}}}{h_{\text{stand}}}$$

Influence of the effective depth for the extraction combination $\Psi_{\text{hef,p}}$								
Metric h_{ef}	M8	M10	M12	M16	M20	M24	M27	M30
64	0.80							
80	1.00	0.89						
90	1.13	1.00						
96	1.20	1.07	0.87					
110	1.38	1.22	1.00					
128	1.60	1.42	1.16	1.00				
160	2.00	1.78	1.45	1.25	0.94			
170		1.89	1.55	1.33	1.00			
192		2.13	1.75	1.50	1.13	0.91		
200		2.22	1.82	1.56	1.18	0.95		
210			1.91	1.64	1.24	1.00		
216			1.96	1.69	1.27	1.03	0.89	
240			2.18	1.88	1.41	1.14	0.99	0.86
243				1.90	1.43	1.16	1.00	0.87
280				2.19	1.65	1.33	1.15	1.00
320				2.50	1.88	1.52	1.32	1.14
400					2.35	1.90	1.65	1.43
480						2.29	1.98	1.71
540							2.22	1.93
600								2.14

Influence of the effective depth for the concrete cone $\Psi_{\text{hef,N}}$								
Metric h_{ef}	M8	M10	M12	M16	M20	M24	M27	M30
64	0.72							
80	1.00	0.84						
90	1.19	1.00						
96	1.31	1.10	0.82					
110	1.61	1.35	1.00					
128	2.02	1.70	1.26	1.00				
160	2.83	2.37	1.75	1.40	0.91			
170		2.60	1.92	1.53	1.00			
192		3.12	2.31	1.84	1.20	0.87		
200		3.31	2.45	1.95	1.28	0.93		
210			2.64	2.10	1.37	1.00		
216			2.75	2.19	1.43	1.04	0.84	
240			3.22	2.57	1.68	1.22	0.98	0.79
243				2.62	1.71	1.24	1.00	0.81
280				3.24	2.11	1.54	1.24	1.00
320				3.95	2.58	1.88	1.51	1.22
400					3.61	2.63	2.11	1.71
480						3.46	2.78	2.24
540							3.31	2.68
600								3.14

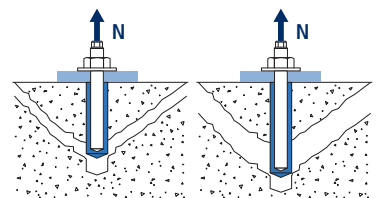

$$\Psi_{\text{hef,N}} = \left(\frac{h_{\text{ef}}}{h_{\text{stand}}} \right)^{1.5}$$



MO-H

SHEARING LOADS

- Calculated steel resistance without lever arm: $V_{Rd,s}$
- Calculated spalling resistance: $V_{Rd,cp} = k \cdot N_{Rd,c}^0$
- Calculated concrete edge resistance: $V_{Rd,c} = V_{Rd,c}^0 \cdot \Psi_b \cdot \Psi_{se,V} \cdot \Psi_{c,V} \cdot \Psi_{re,V} \cdot \Psi_{\alpha,V} \cdot \Psi_{h,V}$

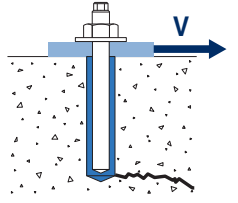
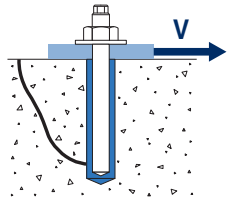
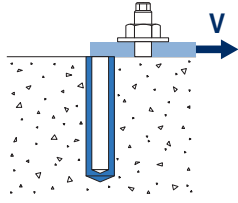

Calculated steel resistance to shearing

		$V_{Rd,s}$								
Metric		M8	M10	M12	M16	M20	M24	M27	M30	
$V_{Rd,s}^0$	Steel class 4.6	[kN]	4.2	7.2	10.2	18.6	29.3	42.5	55.1	67.1
	Steel class 5.8	[kN]	7.2	12.0	16.8	31.2	48.8	70.4	92.0	112.0
	Steel class 8.8	[kN]	12.0	18.4	27.2	50.4	78.4	112.8	147.2	179.2
	Steel class 10.9	[kN]	12.0	19.3	28.0	52.7	82.0	118.0	153.3	187.3
	Stainless steel class A2-70, A4-70	[kN]	8.3	12.8	19.2	35.3	55.1	79.5	103.2	125.6

Calculated spalling resistance

		$V_{Rd,cp} = k \cdot N_{Rd,c}^0$							
Metric		M8	M10	M12	M16	M20	M24	M27	M30
k		2							

Calculated concrete edge resistance

		$V_{Rd,c} = V_{Rd,c}^0 \cdot \Psi_b \cdot \Psi_{se,V} \cdot \Psi_{c,V} \cdot \Psi_{re,V} \cdot \Psi_{\alpha,V} \cdot \Psi_{h,V}$								
Metric		M8	M10	M12	M16	M20	M24	M27	M30	
$V_{Rd,c}^0$	Non-cracked concrete	[kN]	5.7	8.6	11.8	19.0	28.3	36.4	-	55.5
	Cracked concrete	[kN]	4.1	6.1	8.4	13.4	20.1	25.8	-	39.5

Influence coefficients

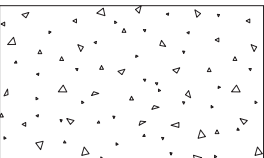

$$\Psi_b = \sqrt{\frac{f_{ck,cube}}{25}} \geq 1$$

Influence of concrete resistance for concrete cone and concrete cracking Ψ_b				
Concrete type	C20/25	C30/37	C40/50	C50/60
Ψ_b	1.00	1.22	1.41	1.55

Influence of the distance from the edge and spacing between anchors $\Psi_{se,V}$																	
For one anchor																	
c/h_{ef}	0.50	0.75	1.00	1.25	1.50	1.75	2.00	2.25	2.50	2.75	3.00	3.25	3.50	3.75	4.00	4.50	5.00
Insulated	0.35	0.65	1.00	1.40	1.84	2.32	2.83	3.38	3.95	4.56	5.20	5.86	6.55	7.26	8.00	9.55	11.18
For two anchors																	
s/c	0.50	0.75	1.00	1.25	1.50	1.75	2.00	2.25	2.50	2.75	3.00	3.25	3.50	3.75	4.00	4.50	5.00
1.0	0.24	0.43	0.67	0.93	1.22	1.54	1.89	2.25	2.64	3.04	3.46	3.91	4.37	4.84	5.33	6.36	7.45
1.5	0.27	0.49	0.75	1.05	1.38	1.74	2.12	2.53	2.96	3.42	3.90	4.39	4.91	5.45	6.00	7.16	8.39
2.0	0.29	0.54	0.83	1.16	1.53	1.93	2.36	2.81	3.29	3.80	4.33	4.88	5.46	6.05	6.67	7.95	9.32
2.5	0.32	0.60	0.92	1.28	1.68	2.12	2.59	3.09	3.62	4.18	4.76	5.37	6.00	6.66	7.33	8.75	10.25
≥ 3.0	0.35	0.65	1.00	1.40	1.84	2.32	2.83	3.38	3.95	4.56	5.20	5.86	6.55	7.26	8.00	9.55	11.18

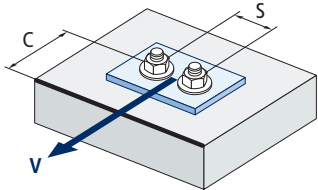
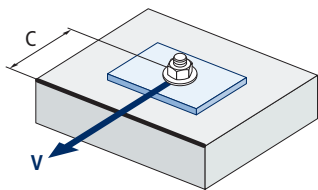

$$\Psi_{se,V} = \left(\frac{c}{h_{ef}}\right)^{1.5}$$

$$\Psi_{se,V} = \left(\frac{c}{h_{ef}}\right)^{1.5} \cdot \left(1 + \frac{s}{3 \cdot c}\right) \cdot 0.5 \leq \left(\frac{c}{h_{ef}}\right)^{1.5}$$



MO-H

Influence of the distance from the edge of the concrete $\Psi_{c,v}$

c/d	4	5	7	10	15	20	25	30
$\Psi_{c,v}$	0.76	0.72	0.68	0.63	0.58	0.55	0.53	0.51

$$\Psi_{c,v} = \left(\frac{d}{c}\right)^{0.20}$$

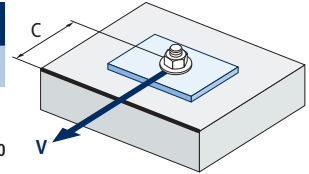

Influence of the effective depth $\Psi_{hef,v}$

h_{ef}/d	8	9	10	11	12	13	14	15	16	17	18	19	20
$\Psi_{hef,v}$	1.65	2.04	2.47	2.93	3.42	3.94	4.50	5.10	5.72	6.38	7.06	7.78	8.53

$$\Psi_{hef,v} = 0.04 \cdot \left(\frac{h_{ef}}{d}\right)^{1.79}$$

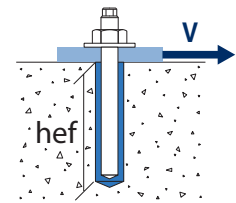

Influence of the rebars $\Psi_{re,v}$

		Without perimeter rebar	Perimeter rebar $\geq \varnothing 12\text{mm}$	Perimeter rebar with abutments at $\leq 100\text{mm}$
$\Psi_{re,v}$	Non-cracked concrete	1	1	1
	Cracked concrete	1	1.2	1.4

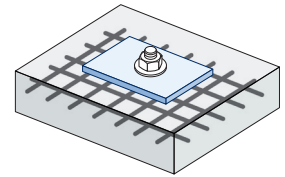

Influence of the load application angle $\Psi_{\alpha,v}$

Angle, $\alpha(^{\circ})$	0°	10°	20°	30°	40°	50°	60°	70°	80°	90°
$\Psi_{\alpha,v}$	1.00	1.01	1.05	1.13	1.24	1.40	1.64	1.97	2.32	2.50

$$\Psi_{\alpha,v} = \sqrt{\frac{1}{(\cos \alpha_v)^2 + \left(\frac{\sin \alpha_v}{2.5}\right)^2}} \geq 1$$

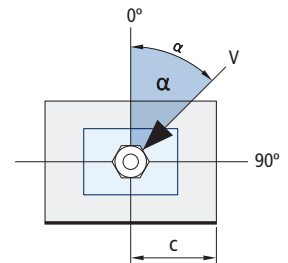

Influence of the base material thickness $\Psi_{h,v}$

h/c	0.15	0.30	0.45	0.60	0.75	0.90	1.05	1.20	1.35	≥ 1.5
$\Psi_{h,v}$	0.32	0.45	0.55	0.63	0.71	0.77	0.84	0.89	0.95	1.00

$$\Psi_{h,v} = \left(\frac{h}{1.5 \cdot c}\right)^{0.5} \geq 1.0$$

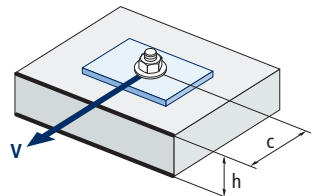





MO-H

FIXING IN BRICKS

INSTALLATION PARAMETERS IN BRICKS. PLASTIC SLEEVE

DIMENSION			M8	M10	M12		
Plastic sleeve	l_s		85	85	85		
	d_o		16	16	20		
Mortar volume per sleeve	[ml]		15	15	27		
h_1	drill hole depth \geq	[mm]	90	90	90		
h_{nom}	sleeve installation depth	[mm]	85	85	85		
h_{ef}	stud depth \geq	[mm]	80	80	80		
t_{fix}	thickness material to be fixed \leq	[mm]	22	25	18		
h_{min}	base material thickness \geq	[mm]	110	110	110		
d_f	diameter in metal sheet \leq	[mm]	9	12	14		
T_{ins}	tightening torque \leq	[Nm]	2	2	2		
Circular brush			$\varnothing 20$				
Stud code			MOES08110	MOES10115	MOES12110		
Sleeve code			MOTN15085	MOTN15085	MOTN20085		
Base material	Plastic sleeve						
	M8, M10			M12			
Minimum distances and from the edge		$c_{cr} = c_{min}$	$s_{cr \parallel} = s_{min}$	$s_{cr \perp} = s_{min \perp}$	$c_{cr} = c_{min}$	$s_{cr \parallel} = s_{min}$	$s_{cr \perp} = s_{min \perp}$
Brick number 1	[mm]	100	245	110	120	245	110
Brick number 2	[mm]	100	373	238	120	373	238

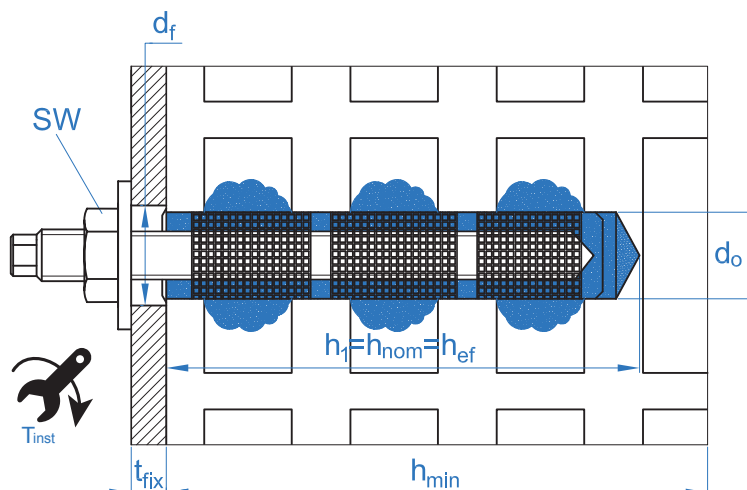



MO-H

INSTALLATION ACCESSORIES			INSTALLATION PROCEDURE
CODE	PRODUCT	MATERIAL	BRICK
MOPISSI	APPLICATION GUNS	Gun for 300 ml cartridges	
MOPISTO		Guns for 410 ml cartridges, professional use	
MOPISNEU		Pneumatic gun for 410 ml coaxial cartridges, professional use	
MO-ES	STUD	Threaded stud	
MORCEPKIT	CLEANING BRUSHES	Kit with 3 cleaning brushes measuring $\varnothing 14$, $\varnothing 20$ and $\varnothing 29$ mm	
MOBOMBA	CLEANING PUMP	Pump for cleaning leftover dust and fragments in the drill hole	
MORCANU	MIXING TUBE	Plastic. Static labyrinth mixture	
MO-TN	NYLON SLEEVE	Plastic white or grey	
MO-TR	THREADED METAL SLEEVE	Threaded metal sleeve M8, M10, M12, zinc-plated	
MO-TM	METAL SLEEVE	Metal sleeve $\varnothing 12$, $\varnothing 16$ and $\varnothing 22$ mm	

MINIMUM CURING TIME			
TYPE	BASE MATERIAL TEMPERATURE [°C]	HANDLING TIME [min]	CURING TIME [min]
MO-H	+5 to +10	10	145
	+10 to +15	8	85
	+15 to +20	6	75
	+20 to +25	5	50
	+25 to +30	4	40
MO-HW	-10 to -5	50	12 hours
	-5 to 0	15	100
	0 to +5	10	75
	+5 to +20	5	50
	+20	100 seconds	20



MO-H

Characteristic resistances (F_{Rk})

Base material	Threaded studs Tensile and shear force [kN]		
	M8	M10	M12
Brick number 1	0.9	1.5	1.5
Brick number 2	2.0	2.0	2.5

Calculated resistances (F_{Rd})

Base material	Threaded studs Tensile and shear force [kN]		
	M8	M10	M12
Brick number 1	0.36	0.60	0.60
Brick number 2	0.80	0.80	1.00

Recommended maximum loads (F_{recom}) (with $\gamma_F = 1.4$)

Base material	Threaded studs Tensile and shear force [kN]		
	M8	M10	M12
Brick number 1	0.26	0.43	0.43
Brick number 2	0.57	0.57	0.71

BRICK TYPES

Brick no. 1

Double hollow clay brick EN 771-1
Length / width / height: 245 mm / 110 mm / 88 mm
 $f_b \geq 2.5 \text{ N/mm}^2$ / $\rho \geq 0.74 \text{ kg/dm}^3$

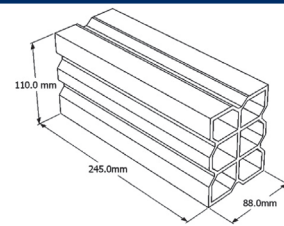

Brick no. 2

Hollow clay brick Porotherm P+W according to EN 771-1
Length / width / height: 373 mm / 250 mm / 238 mm
 $f_b \geq 12 \text{ N/mm}^2$ / $\rho \geq 0.9 \text{ kg/dm}^3$

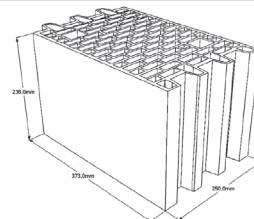



MO-H

RETROFITTED REBAR CONNECTIONS

This technical document covers post-installed rebar connections in non-carbonate concrete under the assumption that post-installed rebar connections are generally calculated according to Eurocode 2. The rebar anchor system comprises the bonding of the material and a straight, recessed reinforcement rebar with the properties specified in Eurocode 2, Annex C; classes B and C.

Dynamic, fatigue or seismic loads on post-installed rebar connections are not covered by this technical document.

Intended use

This technical document covers application in non-carbonate concrete only from C12/15 to C50/60 [EN 206] for the following applications:

- Overlapping bond with an existing rebar in a building component (Figures 1 and 4).
- Fixing of rebar in a slab or in a support. Support at one end of a slab calculated as simply supported as well as its rebars for retention forces (Figure 2).
- Fixing of rebar of construction components mainly subjected to compression (Figure 3).
- Fixing of rebar to cover the action line of the tensile force (Figure 5).

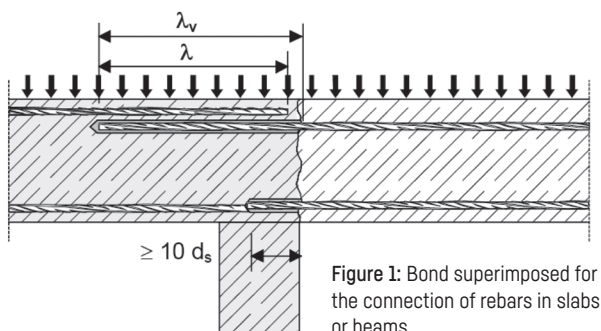

Figure 1: Bond superimposed for the connection of rebars in slabs or beams.

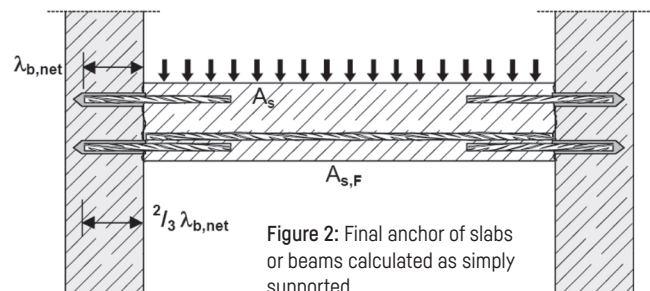

Figure 2: Final anchor of slabs or beams calculated as simply supported.

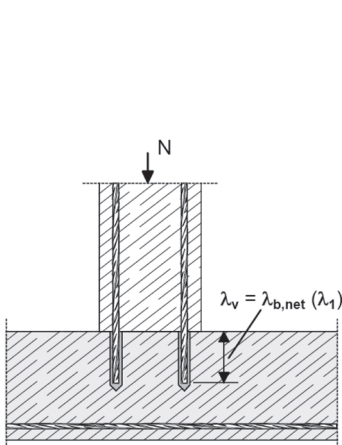

Figure 3: Rebar connections for items primarily subjected to compression. The rebars are subjected to compression.

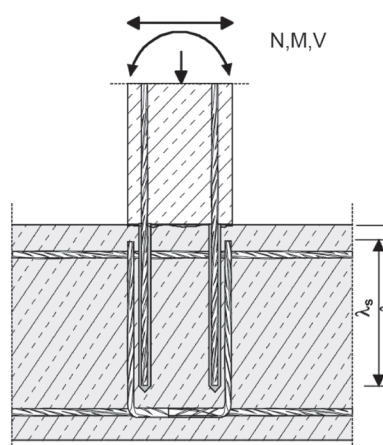

Figure 4: Bond superimposed to a foundation of a column or a wall where the rebars is subjected to tensile force.

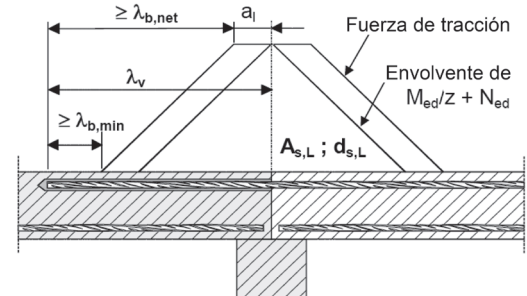

Figure 5: Reinforcement anchor to cover the action line of the tensile force.

* Note for Figure 1 and 5: In the figures the transversal reinforcements have not been represented, the transversal reinforcements as required by the Eurocode 2 must be present. The shear stress transferred between the anterior and posterior concrete must be calculated according to Eurocode 2.



MO-H

The tables shown below refer to Eurocode 2 Annex C, Table C.1 and C2N, rebar properties.

Properties of the start rebars				
Product form		Rebars and unwound rods		
Class		B	C	
Characteristic yield stress f_{yk} or $f_{0.2k}$ (MPa)		400 to 600		
Minimum value of $k = (f_t / f_{yk})_k$		≥ 1.08	≥ 1.15	
Characteristic maximum tensile deformation ϵ_{uk} (%)		≥ 5.0	≥ 7.5	
Flexibility		Bending/folding test		
Maximum deviation from the nominal weight (individual bar or wire) (%)	Nominal size of the rebar (mm) $\leq 8 > 8$	± 6.0		
		± 4.5		
Bonding: Minimum relative corrugated area, $f_{R,min}$	Nominal size of the rebar (mm) 8 to 12	0.040		
	12 > 12	0.056		

Minimum / maximum installation length l_{max}				
Corrugated bars		Minimum		Maximum
		Anchor $l_{b,min}$	Overlapped connection $l_{o,min}$	l_{max}
$\varnothing d_s$ [mm]	$f_{y,k}$ [N/mm ²]	[mm]	[mm]	[mm]
8	500	114	200	400
10	500	142	200	500
12	500	171	200	600
14	500	199	210	700
16	500	227	240	800
20	500	284	300	1000
25	500	355	375	1000

Calculated bonding resistance [N/mm ²] f_{bd}									
Bar \varnothing d_s [mm]	Concrete class								
	C12/15	C16/20	C20/25	C25/30	C30/37	C35/45	C40/50	C45/55	C50/60
8 to 16						3.4	3.7	4.0	4.3
20	1.6	2.0	2.3	2.7	3.0	3.7			
25	3.0								

$$N = f_{bd} \cdot \Phi \cdot L_b \cdot \pi$$



MO-H

Calculated load values according to Eurocode 2 and EOTA technical report TR 023.

- Information according to ETA 13/0780.
- Non-cracked concrete, conditions in dry or wet conditions.
- Temperature range: -40°C to +80°C [maximum long-term temperature +50°C].
- Minimum spacing conditions between bars $\geq 5d_s$, min. 50 mm:

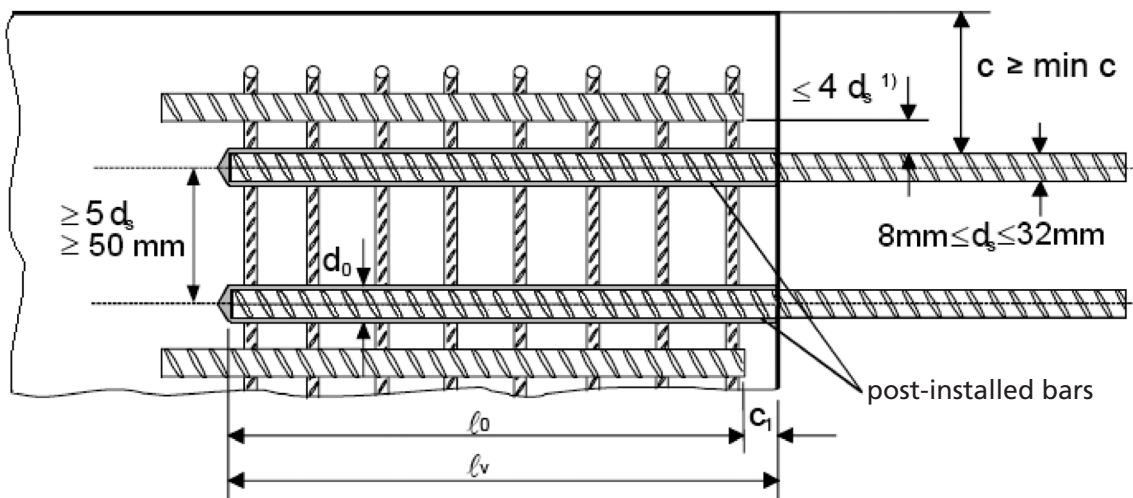

- Minimum concrete coating:
 - drilling with compressed air $\geq 50 + 0.06 L_b$
 - drilling in percussion mode $\geq 30 + 0.08 L_b \geq 2\Phi$
- Good bonding conditions:

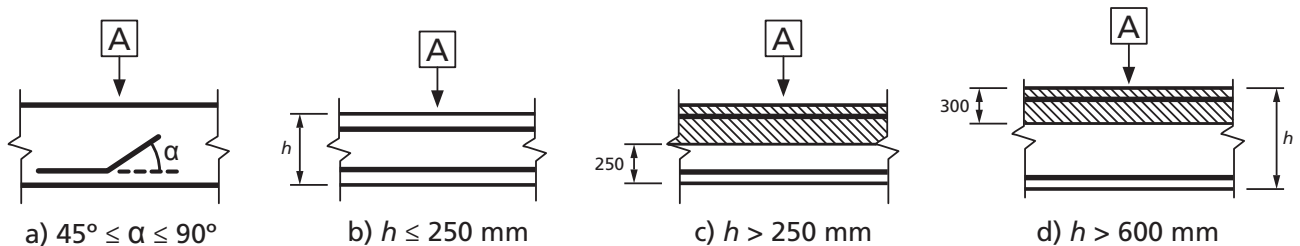

A Direction of the concreting (a) and (b) "good" bonding conditions for all types of bars. (c) and (d) without shaded area - "good" bonding conditions. Shaded area- "poor" bonding conditions.

* In case of poor bonding conditions, multiply values by 0.7.



MO-H

Resistance values may increase in the following situations:

- With transverse tension/compression pressure (α_2)
- In case of concrete coating (α_5)
- In case of overlapping rebars (α_6)

Values for α_2 , α_5 and α_6		
Influence factor	Reinforcement bar	
	A tension	A compression
Concrete coating	$\alpha_2 = 1 - 0.15 (cd - \emptyset) / \emptyset$ ≥ 0.7 ≤ 1.0	$\alpha_2 = 1.0$
Transverse pressure confinement	$\alpha_5 = 1 - 0.004p$ ≥ 0.7 ≤ 1.0	$\alpha_5 = 1.0$
Overlapping length	$\alpha_6 = (p_1 / 25)^{0.25}$ ≥ 1.0 ≤ 1.5	

Where:

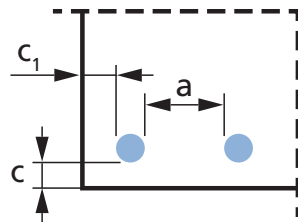

$$c_d = \min (a/2, c_1, c)$$

p : transverse pressure [MPa] in the ultimate limit state I_{bd}

p_1 is the percentage of the overlapped reinforcement bar within $0.65 \cdot l_0$ from the centre of the length of the overlap considered

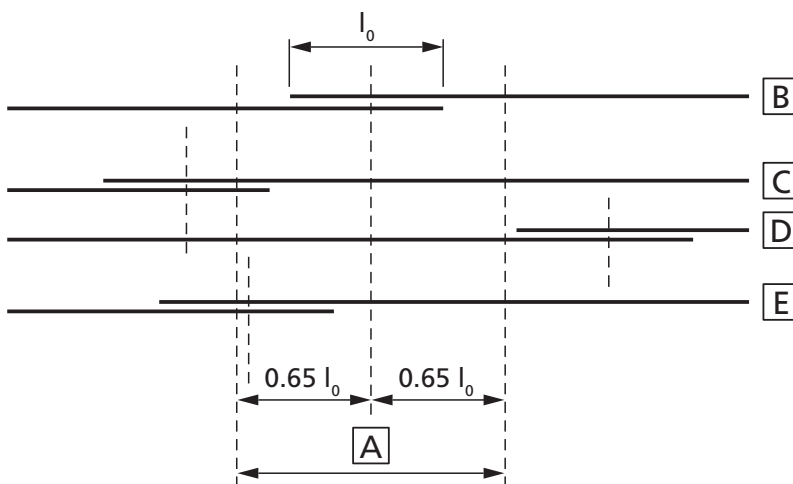

- A** Section considered **B** Bar I **C** Bar II **D** Bar III **E** Bar IV



MO-H

TABLES OF PRECALCULATED VALUES

Concrete class 20/25														
Resistance to concrete compression [$f_{ck,cube}$]: 25 N/mm ²														
Bar Ø	d_s	[mm]	Ø8	Ø10	Ø12	Ø14	Ø16	Ø20	Ø25					
Bar size	d_s	[mm]	8	10	12	14	16	20	25					
Cross-sectional area	A_s	[mm ²]	50.3	78.5	113.1	153.9	201.1	314.2	490.9					
Yield stress of the steel	f_{yd}	[kN]	500	500	500	500	500	500	500					
Safety factor	$\gamma_{M,s}$	[mm ²]	1.15	1.15	1.15	1.15	1.15	1.15	1.15					
Calculated steel resistance	$N_{Rd,s}$	[kN]	21.9	34.1	49.2	66.9	87.4	136.6	213.4					
Calculated bonding resistance	f_{bd}	[N/mm ²]	2.30	2.30	2.30	2.30	2.30	2.30	2.30					
Diameter of the drilled hole	d_h	[mm]	10 ~ 12	12 ~ 14	16	18	20	25	32					
Spacing between bars \geq	s	[mm]	50	50	60	70	80	100	125					
Distance from the edge (drilled using compressed air) \geq	c	[mm]	50 + 0.06 L_b											
Distance from the edge (drilled in percussion mode) \geq	c	[mm]	30 + 0.08 $L_b \geq 2\Phi$											
Anchor length, L_b [mm]			Calculated extraction resistance by bonding*, N_{Rd} [kN]											
114	6.6	Area not permitted												
142	8.2								10.3					
171	9.9								12.4	14.8				
200	11.6								14.5	17.3	20.2			
210	12.1								15.2	18.2	21.2			
227	13.1								16.4	19.7	23.0	26.2		
240	13.9								17.3	20.8	24.3	27.7		
284	16.4								20.5	24.6	28.7	32.8	41.0	
300	17.3								21.7	26.0	30.3	34.7	43.4	
355	20.5								25.7	30.8	35.9	41.0	51.3	64.1
375	21.7	27.1	32.5	37.9	43.4	54.2	67.7							
400	21.9	28.9	34.7	40.5	46.2	57.8	72.3							
500		34.1	43.4	50.6	57.8	72.3	90.3							
600			49.2	60.7	69.4	86.7	108.4							
700				66.9	80.9	101.2	126.4							
800					87.4	115.6	144.5							
900		Yield stress area of the bar					130.1	162.6						
1000						136.6	180.6							
Length for reaching the yield stress of the steel, $L_{b,reqd}$ [mm]			378	473	567	662	756	945	1181					

Values shaded in blue are not valid for overlap bonds

* Values valid for ($\alpha_2=\alpha_3=\alpha_6=1$). In case of poor bonding conditions, multiply values by 0.7.



MO-H

TABLES OF PRECALCULATED VALUES

Concrete class 30/37														
Resistance to concrete compression [$f_{ck,cube}$]: 37 N/mm ²														
Bar Ø	d_s	[mm]	Ø8	Ø10	Ø12	Ø14	Ø16	Ø20	Ø25					
Bar size	d_s	[mm]	8	10	12	14	16	20	25					
Cross-sectional area	A_s	[mm ²]	50.3	78.5	113.1	153.9	201.1	314.2	490.9					
Yield stress of the steel	f_{yd}	[kN]	500	500	500	500	500	500	500					
Safety factor	$\gamma_{M,s}$	[mm ²]	1.15	1.15	1.15	1.15	1.15	1.15	1.15					
Calculated steel resistance	$N_{Rd,s}$	[kN]	21.9	34.1	49.2	66.9	87.4	136.6	213.4					
Calculated bonding resistance	f_{bd}	[N/mm ²]	3.00	3.00	3.00	3.00	3.00	3.00	3.00					
Diameter of the drilled hole	d_h	[mm]	10 ~ 12	12 ~ 14	16	18	20	25	32					
Spacing between bars ≥	s	[mm]	50	50	60	70	80	100	125					
Distance from the edge (drilled using compressed air) ≥	c	[mm]	50 + 0.06 L_b											
Distance from the edge (drilled in percussion mode) ≥	c	[mm]	30 + 0.08 L_b ≥ 2Φ											
Anchor length, L_b [mm]			Calculated extraction resistance by bonding*, N_{Rd} [kN]											
114	8.6	Area not permitted												
142	10.7								13.4					
171	12.9								16.1	19.3				
200	15.1								18.8	22.6	26.4			
210	15.8								19.8	23.8	27.7			
227	17.1								21.4	25.7	30.0	34.2		
240	18.1								22.6	27.1	31.7	36.2		
284	21.4								26.8	32.1	37.5	42.8	53.5	
300	21.9								28.3	33.9	39.6	45.2	56.5	
355	21.9								33.5	40.1	46.8	53.5	66.9	83.6
375	21.9								34.1	42.4	49.5	56.5	70.7	88.4
400	21.9								34.1	45.2	52.8	60.3	75.4	94.2
500									34.1	49.2	66.0	75.4	94.2	117.8
600										49.2	66.9	87.4	113.1	141.4
700											66.9	87.4	131.9	164.9
800												87.4	136.6	188.5
900									Yield stress area of the bar					136.6
1000						136.6	213.4							
Length for reaching the yield stress of the steel, $L_{b,rqd}$ [mm]			290	362	435	507	580	725	906					

Values shaded in blue are not valid for overlap bonds

* Values valid for ($\alpha_2=\alpha_3=\alpha_6=1$). In case of poor bonding conditions, multiply values by 0.7.



MO-H

TABLES OF PRECALCULATED VALUES

Concrete class 40/50										
Resistance to concrete compression [$f_{ck,cube}$]: 50 N/mm ²										
Bar Ø	d_s	[mm]	Ø8	Ø10	Ø12	Ø14	Ø16	Ø20	Ø25	
Bar size	d_s	[mm]	8	10	12	14	16	20	25	
Cross-sectional area	A_s	[mm ²]	50.3	78.5	113.1	201.1	314.2	314.2	490.9	
Yield stress of the steel	f_{yd}	[kN]	500	500	500	500	500	500	500	
Safety factor	$\gamma_{M,s}$	[mm ²]	1.15	1.15	1.15	1.15	1.15	1.15	1.15	
Calculated steel resistance	$N_{Rd,s}$	[kN]	21.9	34.1	49.2	87.4	136.6	136.6	213.4	
Calculated bonding resistance	f_{bd}	[N/mm ²]	2.3	2.3	2.3	2.3	2.3	2.3	2.3	
Diameter of the drilled hole	d_h	[mm]	10 ~ 12	12 ~ 14	16	18	20	25	32	
Spacing between bars \geq	s	[mm]	50	50	60	80	100	100	125	
Distance from the edge (drilled using compressed air) \geq	c	[mm]	50 + 0.06 L_b							
Distance from the edge (drilled in percussion mode) \geq	c	[mm]	30 + 0.08 $L_b \geq 2\Phi$							
Anchor length, L_b [mm]			Calculated extraction resistance by bonding*, N_{Rd} [kN]							
114	10.6									
142	13.2	16.5							Area not permitted	
171	15.9	19.9	23.9							
200	18.6	23.2	27.9	32.5						
210	19.5	24.4	29.3	34.2						
227	21.1	26.4	31.7	36.9	42.2					
240	21.9	27.9	33.5	39.1	44.6					
284	21.9	33.0	39.6	46.2	52.8	66.0				
300	21.9	34.1	41.8	48.8	55.8	69.7				
355	21.9	34.1	49.2	57.8	66.0	82.5	83.6			
375	21.9	34.1	49.2	61.0	69.7	87.2	88.4			
400	21.9	34.1	49.2	65.1	74.4	93.0	94.2			
500		34.1	49.2	66.9	87.4	116.2	117.8			
600			49.2	66.9	87.4	136.6	141.4			
700				66.9	87.4	136.6	164.9			
800					87.4	136.6	188.5			
900		Yield stress area of the bar					136.6	212.1		
1000						136.6	213.4			
Length for reaching the yield stress of the steel, $L_{b,Rqd}$ [mm]	235	294	352	411	470	587	906			

Values shaded in blue are not valid for overlap bonds

* Values valid for ($\alpha_2=\alpha_3=\alpha_6=1$). In case of poor bonding conditions, multiply values by 0.7.



MO-H

TABLES OF PRECALCULATED VALUES

Concrete class 50/60										
Resistance to concrete compression [$f_{ck,cube}$]: 60 N/mm ²										
Bar Ø	d_s	[mm]	Ø8	Ø10	Ø12	Ø14	Ø16	Ø20	Ø25	
Bar size	d_s	[mm]	8	10	12	14	16	20	25	
Cross-sectional area	A_s	[mm ²]	50.3	78.5	113.1	153.9	201.1	314.2	490.9	
Yield stress of the steel	f_{yd}	[kN]	500	500	500	500	500	500	500	
Safety factor	$\gamma_{M,s}$	[mm ²]	1.15	1.15	1.15	1.15	1.15	1.15	1.15	
Calculated steel resistance	$N_{Rd,s}$	[kN]	21.9	34.1	49.2	66.9	87.4	136.6	213.4	
Calculated bonding resistance	f_{bd}	[N/mm ²]	4.30	4.30	4.30	4.30	4.30	3.70	3.00	
Diameter of the drilled hole	d_h	[mm]	10 ~ 12	12 ~ 14	16	18	20	25	32	
Spacing between bars \geq	s	[mm]	50	50	60	70	80	100	125	
Distance from the edge (drilled using compressed air) \geq	c	[mm]	50 + 0.06 L_b							
Distance from the edge (drilled in percussion mode) \geq	c	[mm]	30 + 0.08 $L_b \geq 2\Phi$							
Anchor length, L_b [mm]			Calculated extraction resistance by bonding*, N_{Rd} [kN]							
114	12.3									
142	15.3	19.2							Area not permitted	
171	18.5	23.1	27.7							
200	21.6	27.0	32.4	37.8						
210	21.9	28.4	34.0	39.7						
227	21.9	30.7	36.8	42.9	49.1					
240	21.9	32.4	38.9	45.4	51.9					
284	21.9	34.1	46.0	53.7	61.4	66.0				
300	21.9	34.1	48.6	56.7	64.8	69.7				
355	21.9	34.1	49.2	66.9	76.7	82.5	83.6			
375	21.9	34.1	49.2	66.9	81.1	87.2	88.4			
400	21.9	34.1	49.2	66.9	86.5	93.0	94.2			
500		34.1	49.2	66.9	87.4	116.2	117.8			
600			49.2	66.9	87.4	136.6	141.4			
700				66.9	87.4	136.6	164.9			
800					87.4	136.6	188.5			
900			Yield stress area of the bar				136.6	212.1		
1000						136.6	213.4			
Length for reaching the yield stress of the steel, $L_{b,reqd}$ [mm]			202	253	303	354	404	587	906	

Values shaded in blue are not valid for overlap bonds

* Values valid for ($\alpha_2=\alpha_3=\alpha_6=1$). In case of poor bonding conditions, multiply values by 0.7.



RANGE 300 ml



MO-H

EPOXY VINYLESTER WITHOUT STYRENE



CODE	DIMENSION	
NORMAL		
MO-H300	300 ml	12
MO-H410	410 ml	12
COLOUR STONE		
MO-HW300	300 ml	12
MO-HW410	410 ml	12

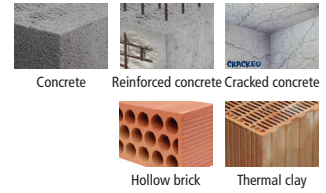

Accessories for chemical anchor cartridges

MO-PIS Application guns



CODE	MODEL
MOPISTO	Manual
MOPISPR	Professional 410 ml
MOPISSI	Silicone 300 ml
MOPISEU	Pneumatic

MO-TN Plastic sleeve



CODE	DIMENSION
MOTN12050	12 x 50
MOTN15085	15 x 85
MOTN15130	15 x 130
MOTN20085	20 x 85

MO-AC Mixing tubes and miscellaneous



CODE	MODEL
MOBOMBA	Blower pump
MORCANU	Tube 170 - 300 - 410 ml
MORCEPKIT	Kit 3 brushes

MO-ES Threaded stud



CODE	DIMENSION
MOES06070	M6 x 70
MOES08110	M8 x 110
MOES10115	M10 x 115
MOES12110	M12 x 110

MO-TM Metal sleeve

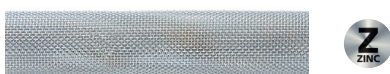

CODE	DIMENSION
MOTM12100	12 x 1000
MOTM16100	16 x 1000
MOTM22100	22 x 1000

MO-TR Threaded sleeve

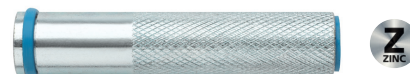

CODE	DIMENSION
MOTR008	M8/12 x 80
MOTR010	M10/14 x 80
MOTR012	M12/16 x 80



MO-H

Accessories for chemical anchor cartridges

Stud for chemical anchor with nut and washer



EQ-AC Zinc-plated

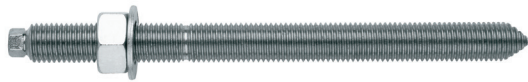

CODE	DIMENSION
EQAC08110	M8 x 110
EQAC10130	M10 x 130
EQAC12160	M12 x 160
EQAC16190	M16 x 190
EQAC20260	M20 x 260
EQAC24300	M24 x 300
EQAC30330	M30 x 330

EQ-A2 Stainless steel A2



CODE	DIMENSION
EQA208110	M8 x 110
EQA210130	M10 x 130
EQA212160	M12 x 160
EQA216190	M16 x 190
EQA220260	M20 x 260
EQA224300	M24 x 300
EQA230330	M30 x 330

EQ-A4 Stainless steel A4

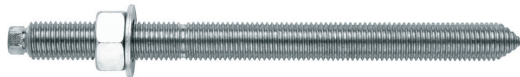

CODE	DIMENSION
EQA408110	M8 x 110
EQA410130	M10 x 130
EQA412160	M12 x 160
EQA416190	M16 x 190
EQA420260	M20 x 260
EQA424300	M24 x 300
EQA430330	M30 x 330